

**ENDURANCE TECHNOLOGY™**

# ERD ELECTRIC ROD-STYLE ACTUATOR

PATENT PENDING





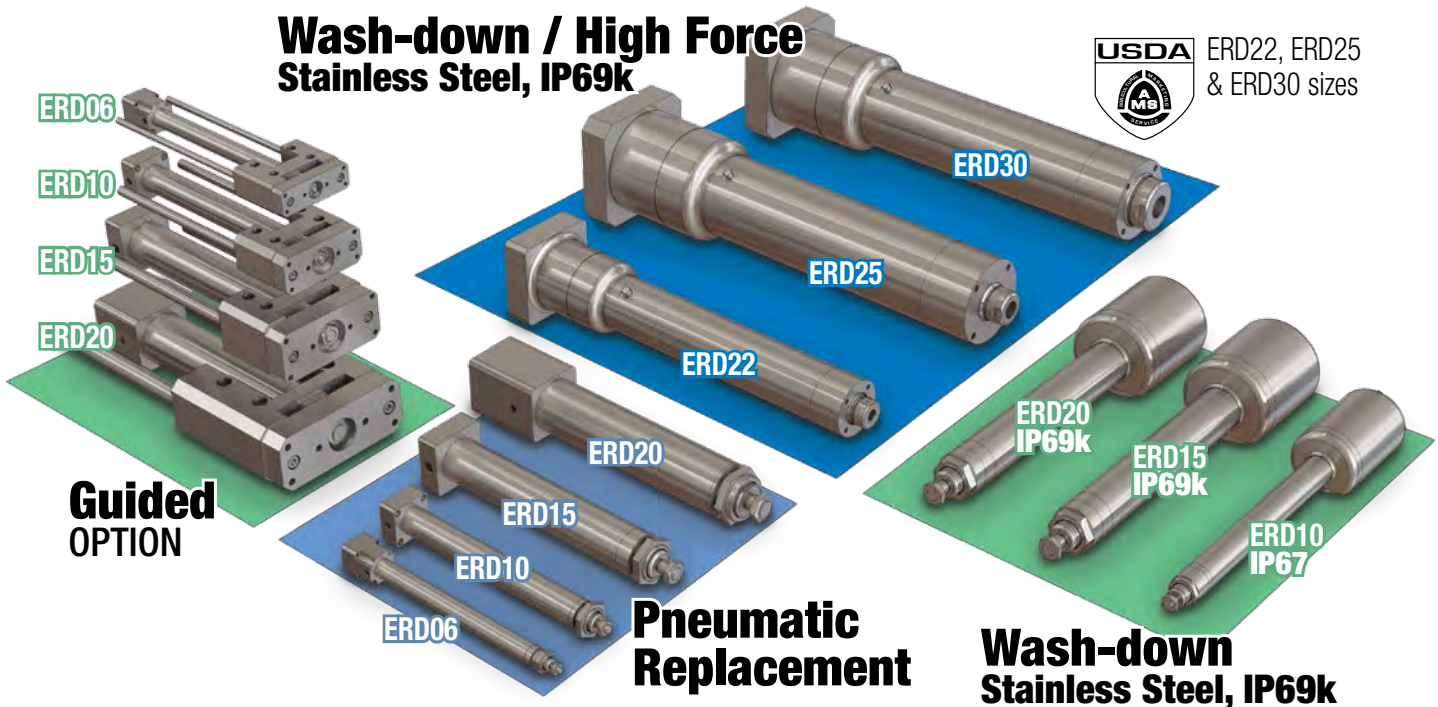

**LINEAR SOLUTIONS MADE EASY**

# ERD – Electric Rod-Style Actuator

The ERD is an economical rod-style electric actuator designed as an alternate to pneumatic cylinders, a cost effective actuator for general automation and an option for automating manual processes. In addition, the ERD is available with all stainless steel and IP69k options which makes it the ideal hygienic actuator for the food & beverage processing environment.



## TOLOMATIC'S ELECTRIC ROD-STYLE ACTUATORS

	<b>ERD</b>	<b>ICR</b>	<b>RSA</b>	<b>GSA</b>	<b>IMA</b>
					
	<b>Rod-Style Actuator</b>	<b>Integrated Control Rod-Style Actuator</b>	<b>Rod-Style Actuator</b>	<b>Guided Rod-Style Actuator</b>	<b>Integrated Motor Rod-Style Actuator</b>
<b>Thrust</b> up to:	4,500 lbf [20,017 N]	720 lbf [3,202.7 N]	12,900 lbf [57,382 N]	950 lbf [4,226 N]	6,875 lbf [30,594 N]
<b>Speed</b> up to:	58 in/sec [1473 mm/sec]	25 in/sec [635 mm/sec]	123 in/sec [3,124 mm/sec]	123 in/sec [3,124 mm/sec]	52.5 in/sec [1,334 mm/sec]
<b>Stroke Length</b> up to:	39.4 in [1000 mm]	24 in [609 mm]	60 in [1,524 mm]	36 in [914 mm]	18 in [457 mm]
<b>Screw/Nut Type</b>	Solid, Ball & Roller	Ball	Solid, Ball & Roller	Solid & Ball	Ball & Roller
	<i>For complete information see <a href="http://www.tolomatic.com">www.tolomatic.com</a> or literature number:</i>				
<b>Literature Number:</b>	2190-4000	2100-4000	3600-4609	3600-4609	2700-4000

*(Not all models deliver maximum values listed, i.e.: Maximum thrust may not be available with maximum speed)*

# ERD – Applications

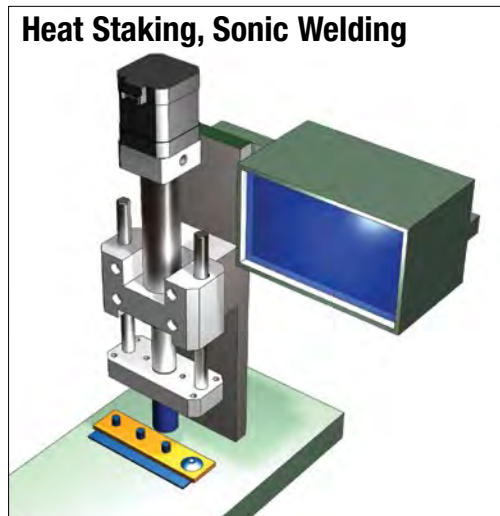
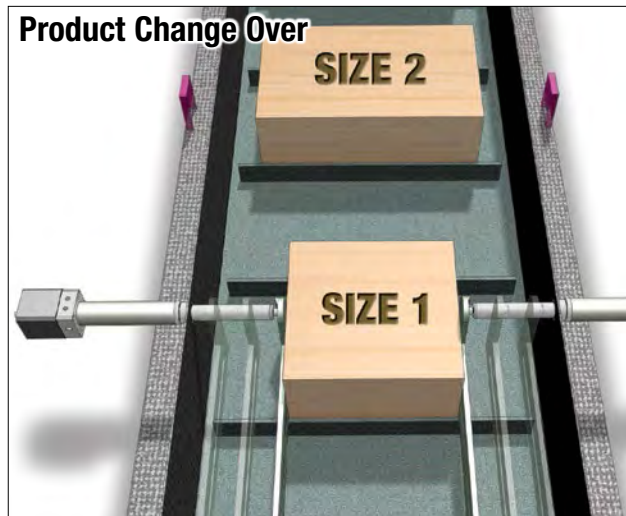
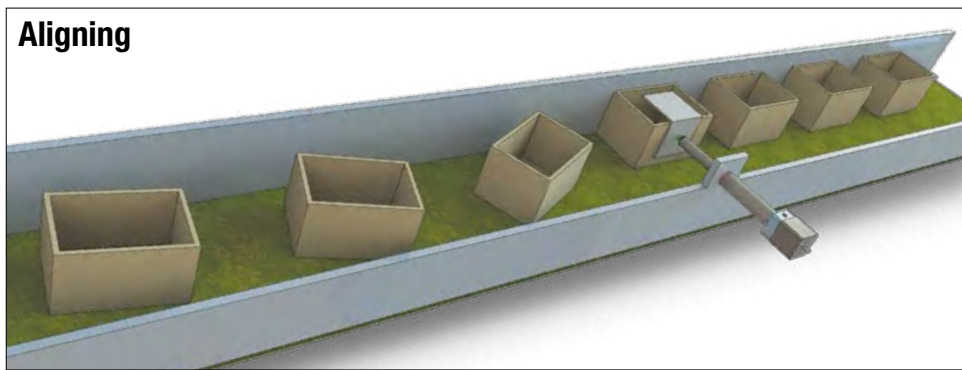
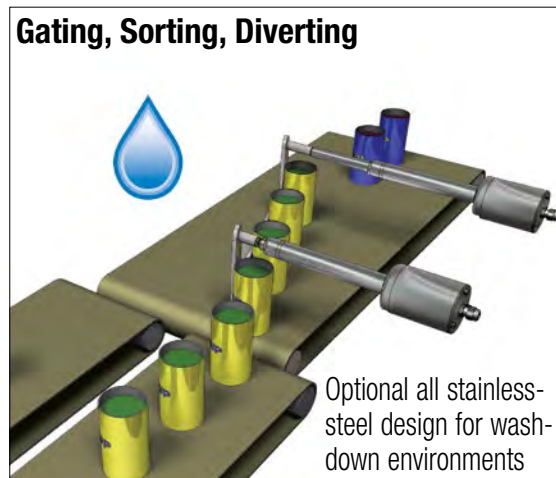
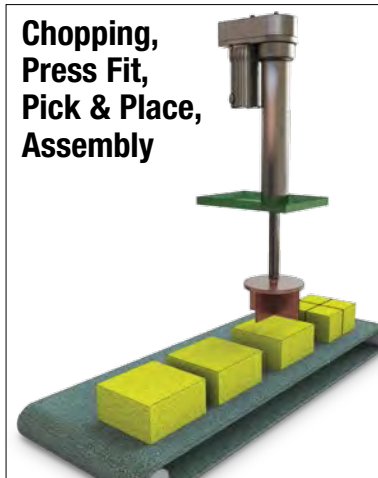

## CONTENTS

What is the ERD . . . . .ERD\_2

Rod-Style Actuators . . .ERD\_2

Applications . . . . .ERD\_3

**FEATURES**

ERD . . . . .ERD\_4

ERD SS2 . . . . .ERD\_6

**SPECIFICATIONS**

ERD . . . . .ERD\_8

**PERFORMANCE**

ERD . . . . .ERD\_10

GD2 . . . . .ERD\_18

**DIMENSIONS**

ERD-06, 10, 15, 20

**Actuator** . . . . .ERD\_20

**Options:** IP67 . . . . .ERD\_20

FFG, FM2, TRR, PCD . .ERD\_21

GD2, SS2 . . . . .ERD\_22

ERD-22, 25, 30

**Actuator** . . . . .ERD\_23

**Options:** FFG . . . . .ERD\_23

FM2, TRR, HYG1 . . . .ERD\_24

Alternative Motors . . .ERD\_25

**SWITCHES** . . . . .ERD\_26

Appl. Data Worksheet .ERD\_28

Selection Guidelines . .ERD\_29

Service Parts . . . . .ERD\_30

Ordering . . . . .ERD\_31

## Other Applications:

- Aligning
- Animation
- Assembly
- Automatic tool changers
- Automotive
- Converting
- Conveyors
- Diverting
- Fillers
- Formers
- Gating
- Heat staking
- Laser positioning
- Material handling systems
- Medical equipment
- Motion simulators
- Open / close doors
- Packaging equipment
- Parts clamping
- Patient lifts
- Pick & place
- Plate positioning change
- Press fit
- Product changeover
- Product test simulations
- Robot manipulator arms
- Sonic welding
- Sorting
- Table positioning
- Tension control
- Test stands
- Volumetric pumps
- Web guidance
- Wire winding

# ERD – ELECTRIC ROD-STYLE ACTUATOR

**ENDURANCE TECHNOLOGY<sup>SM</sup>**

Endurance Technology features are designed for maximum durability to provide extended service life.

The ERD is an economical rod-style electric actuator designed as an alternate to pneumatic cylinders and an option for automating manual processes. The ERD is compatible with many NEMA & metric mount stepper and servo motors to create a flexible, powerful electric actuator solution. Built-to-order in stroke lengths up to 39.4 inches.

## • PATENTED •

### • THREADED NOSE MOUNT WITH JAM NUT

- Metric threads
- Convenient mounting for many applications (06, 10, 15, 20 sizes)



### • THREADED ROD END •

- Compatible with many commercially available metric rod end accessories
- Standard metric threads
- 06, 10, 15, 20 male threads; 22, 25, 30 female threads

### • MULTIPLE SCREW TECHNOLOGIES YOU CAN CHOOSE:

- Solid nuts (06, 10, 15 sizes) of engineered resins offer quiet performance at the lowest cost; anti-backlash available
- Ball nuts (10, 15, 20, 22, 25, 30 sizes) offer efficiency at a cost effective price; low-backlash available
- Roller nuts provide the highest thrust and life ratings available (22, 25 size Only)



### • OVERSIZED MAIN BEARING

- Oversized for long life
- Accommodates high thrust load

### • THREADED NOSE MOUNT WITH JAM NUT

- Metric threads
- Convenient mounting for many applications (06, 10, 15, 20 sizes)



### • THREADED ROD END •

- Compatible with many commercially available metric rod end accessories
- Standard metric threads
- 06, 10, 15, 20 male threads; 22, 25, 30 female threads

### • MULTIPLE SCREW TECHNOLOGIES YOU CAN CHOOSE:

- Solid nuts (06, 10, 15 sizes) of engineered resins offer quiet performance at the lowest cost; anti-backlash available
- Ball nuts (10, 15, 20, 22, 25, 30 sizes) offer efficiency at a cost effective price; low-backlash available
- Roller nuts provide the highest thrust and life ratings available (22, 25 size Only)



### • OVERSIZED MAIN BEARING

- Oversized for long life
- Accommodates high thrust load

### • INTERNAL MAGNET

- This standard feature accommodates reed and solid state switches anywhere on the main tube

### • NOSE BEARING

- Engineered resins for smooth operation
- Provides critical support of thrust rod

### • 300 SERIES STAINLESS-STEEL MAIN TUBE

- 300 Series stainless-steel main tube provides high rigidity and corrosion resistance

### • STAINLESS-STEEL THRUST TUBE

- 300 series stainless-steel thrust tube provides high rigidity and corrosion resistance

• **MOTOR ORIENTATION & MOTOR CHOICES** •

**LM1** – INLINE

- Inline option directly couples the driving shaft and is typically a one-piece housing construction for optimum alignment and support of the motor

**RP** – REVERSE PARALLEL

- Reverse-parallel option minimizes the overall length and offers a belt reduction drive with a 1:1 or 2:1 ratio.

**NEMA OR  
YOUR MOTOR  
HERE**

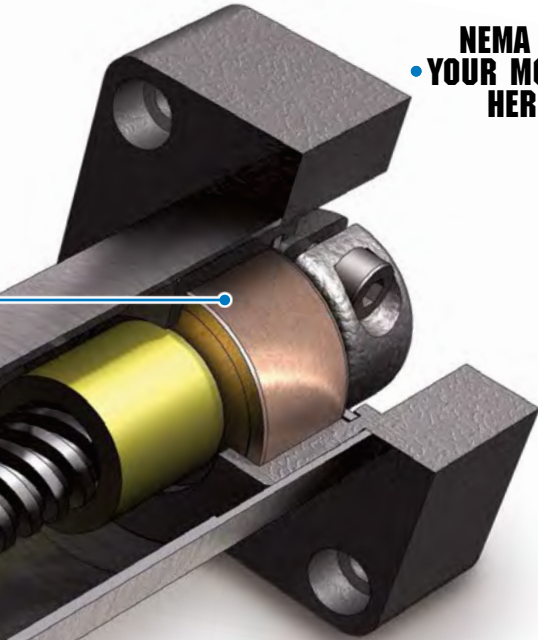

• **GUIDE (GD2 OPTION)** •

- Load guidance, tooling plate and anti-rotate
- Made of aluminum (06, 10, 15, 20 sizes)

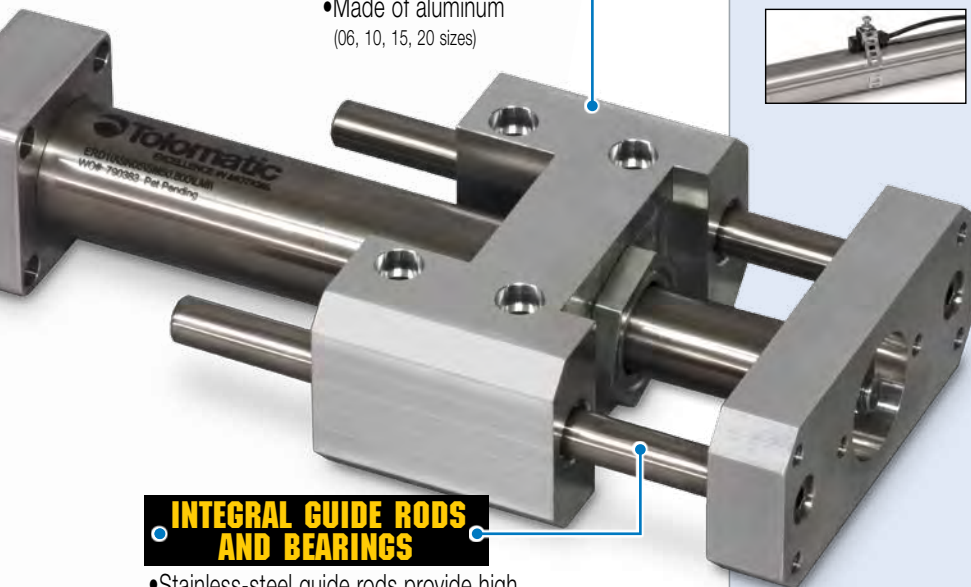

**INTEGRAL GUIDE RODS AND BEARINGS**

- Stainless-steel guide rods provide high rigidity and low deflection
- Four composite bearings support the load for smooth consistent motion

**OPTIONS**



• **TRR** – TRUNNION MOUNT

For applications that require pivoting, 300 series stainless steel construction. Available on all sizes



• **PCD** – REAR CLEVIS MOUNT

For applications that require rear pivot, (Available for 15, 20, 22, 25, 30 sizes with **RP** mounting only)



• **FM2** – FOOT MOUNT\*

For applications that require bottom mounting, 300 series stainless steel construction. Available on all sizes



• **FFG** – FRONT FLANGE MOUNT\*

For front mounting applications, 300 series stainless steel construction. Available on all sizes



• **SWITCHES\***

Choose from: Reed, Solid State PNP or NPN, all available in normally open. Available on all sizes

• **ARI** – INTERNAL ANTI-ROTATE

When anti-rotation is required. For 15, 20, 22, 25, 30 sizes.

• **IP67 & IP69K** RATINGS

An IP67 upgrade (static rating) for protection against water and dust ingress IP69k also protects from high pressure washdown (see page ERD\_31 for ordering details)

• **SS1** – STAINLESS STEEL

Same ERD actuator made of all 300 series stainless steel for corrosion resistance. For 06, 10, 15, 20, 22, 25, 30 sizes.

• **SS2** – STAINLESS STEEL

SS1 option plus IP67 or IP69k and protective motor enclosure (see page ERD\_6) Available on 10, 15, 20 sizes

• **GD2** – GUIDE

For applications that require anti-rotation, or guidance and load bearing. Made of lightweight aluminum Available on 06, 10, 15, 20 sizes

\*NOTE: Foot Mount, Front Flange Mount and Switches are shipped together with the actuator but are not installed by Tolomatic.

# SS2 OPTION – ERD15 & ERD20

## ALL 300 SERIES STAINLESS STEEL, IP69K, MOTOR PROTECTION

Note: ERD10SS2 available in IP67

### ENDURANCE TECHNOLOGY<sup>SM</sup>

Endurance Technology features are designed for maximum durability to provide extended service life.

The all 300 series stainless-steel ERD incorporates hygienic design principles and has an IP69k rating (static) that includes a protective enclosure for Tolomatic stepper/servo motors. This option is available for the 15 & 20 sizes, the SS2 is built-to-order in stroke lengths up to 24 inches. (10 size: IP67 and stepper motor only)

#### FLEXIBLE CONNECTION

- Choice of cord grips (PVDF) or industry standard conduit threads



SS23  
1 or 2 cord grips determined if encoder is selected



SS21  
NPT 1/2" conduit thread  
&  
SS22  
M20x1.5 conduit thread

#### SMOOTH EXTERIOR

- This primary design decision eases cleanup and helps to prevent bacterial growth

#### IP69K RATED

- To withstand high-pressure wash-down

#### MOTOR PROTECTION

- Motor enclosure made of stainless steel designed to protect motor with IP69k rating (static)

**Tolomatic**... MAXIMUM DURABILITY  
EXCELLENCE IN MOTION<sup>®</sup>

# ERD22, 25 & ERD30 STANDARD

## ALL 300 SERIES STAINLESS STEEL, IP69K

The all 300 series stainless-steel ERD incorporates hygienic design principles and has an IP69k rating (static). Available in 22, 25 & 30 sizes, the ERD is built-to-order in stroke lengths up to 39.4 inches with force up to 4,500 lbf.



- **HYGI** Option: USDA approved hygienic design [NSF/ANIS3-A 14159-1-2010] (see #2190-4003 for usage details)

### BREATHER / PURGE PORT

- Helps prevent contaminants from entering into actuator

### WELDED SEAMS

- Leaving no gaps which eases cleanup and helps to prevent bacterial growth

### USDA SCRAPER

- Available with USDA certified option **HYGI**

### ALL 300 SERIES STAINLESS STEEL CONSTRUCTION

- 300 series stainless steel for corrosion resistance
- The perfect electric actuator solution for food & beverage processing equipment

### DURABLE SEALS

- Polyurethane for IP69k ingress protection and resistance to caustic wash-down

### STAINLESS STEEL FASTENERS

- Standard metric threads
- Hex fasteners for sturdy construction without potential particle collection areas

### THREADED ROD END

- Compatible with many commercially available metric rod end accessories
- Standard metric threads
- 06, 10, 15, 20 male threads; 22, 25, 30 female threads

# ERD – Electric Rod-Style Actuator



SIZE: ALL

## SPECIFICATIONS

### SPECIFICATIONS (US conventional measurement)

ERD SIZE	MAXIMUM STROKE*	SCREW DIA.	SCREW CODE	LEAD	LEAD ACCURACY	BACKLASH	MAXIMUM THRUST	DYNAMIC LOAD RATING	INERTIA			WEIGHT					WEIGHT (GD2 adder)		
									LMI	RP		LMI (AL)	LMI (SS)	RP (AL)	RP (SS)	(SS2 adder)		Base	Per Inch
									Base	Base	Per Inch	Base	Base	Base	Base	Base	Per Inch	Base	Per Inch
in	in	in	in/rev	in/ft	in	lbf	lbf	lb-in <sup>2</sup>	lb-in <sup>2</sup>	lb-in <sup>2</sup>	lb	lb	lb	lb	lb	lb	lb	lb	
06	8	0.250	SN02	0.500	0.005	0.007	20	NA	0.0018	–	0.0001	0.263	–	–	–	–	0.035	0.579	0.027
		0.250	SN04	0.250	0.005	0.007	20	NA	0.0018	–	0.0001	0.263	–	–	–	–	0.035	0.579	0.027
		0.250	SN16	0.063	0.005	0.007	20	NA	0.0018	–	0.0001	0.263	–	–	–	–	0.035	0.579	0.027
10	10	0.375	SN01	1.000	0.007	0.007	40	NA	0.0022	–	0.0006	0.411	–	–	–	2.280	0.069	1.028	0.061
		0.375	SN02	0.500	0.007	0.007	40	NA	0.0022	–	0.0006	0.411	–	–	–	2.280	0.069	1.028	0.061
		0.375	SN05	0.200	0.007	0.007	40	NA	0.0022	–	0.0006	0.411	–	–	–	2.280	0.069	1.028	0.061
		0.472	BNM05	0.197	0.004	0.005	100	240	0.0040	–	0.0014	0.607	–	–	–	2.280	0.087	1.028	0.061
15	12	0.500	SN01	1.000	0.006	0.007	75	NA	0.0104	0.2101	0.0017	1.079	–	4.230	7.761	5.771	0.126	2.297	0.095
		0.500	SN02	0.500	0.005	0.007	75	NA	0.0104	0.2101	0.0017	1.079	–	4.230	7.761	5.771	0.126	2.297	0.095
		0.500	SN05	0.200	0.006	0.007	75	NA	0.0104	0.2101	0.0017	1.079	–	4.230	7.761	5.771	0.126	2.297	0.095
	24	0.630	BNM05	0.197	0.004	0.005	200	450	0.0178	0.2208	0.0044	1.170	–	4.230	7.761	5.771	0.159	2.297	0.095
		0.630	BNM10	0.394	0.004	0.005	200	400	0.0178	0.2208	0.0044	1.170	–	4.230	7.761	5.771	0.159	2.297	0.095
20	24	0.984	BNM05	0.197	0.004	0.005	500	900	0.0628	0.4102	0.0263	7.575	–	23 FRM	23 FRM	7.552	0.325	6.455	0.256
		0.984	BNM10	0.394	0.004	0.005	500	900	0.0628	0.4102	0.0263	7.575	–	5.610	9.030	7.552	0.325	6.455	0.256
		0.787	BNM20	0.788	0.004	0.004	500	2560	0.0628	0.4102	0.0105	7.575	–	34 FRM	34 FRM	7.552	0.325	6.455	0.256
22	39.4	0.750	BN02	0.500	0.004	0.015	1600	2836	0.4449	0.5489	0.0086	–	11.05	–	20.18	–	0.43		
		0.750	BN05	0.200	0.003	0.015	950	1624	0.4449	0.5489	0.0086	–	11.05	–	20.18	–	0.43		
		0.625	BNM05	0.197	0.002	0.004	1000	1958	0.4267	0.5307	0.0044	–	10.81	–	19.94	–	0.40		
		0.625	BNM10	0.394	0.002	0.004	900	1214	0.4267	0.5307	0.0044	–	10.81	–	19.94	–	0.40		
		0.790	BNM20	0.787	0.004	0.004	1000	2560	0.4527	0.5567	0.0105	–	11.12	–	20.25	–	0.45		
	16	0.590	RN05	0.197	0.0004	0.0012	1700	7872	0.4226	0.5266	0.0033	–	10.79	–	19.92	–	0.39		
		0.590	RN10	0.394	0.0004	0.0012	850	6805	0.4226	0.5266	0.0033	–	10.79	–	19.92	–	0.39		
25	39.4	1.000	BN01	1.000	0.004	0.002	711	2500	0.8634	0.7749	0.0277	–	31.77	–	53.85	–	0.87		
		1.000	BN02	0.500	0.004	0.015	1423	5418	0.8634	0.7749	0.0277	–	31.73	–	53.81	–	0.87		
		1.000	BN04	0.250	0.004	0.015	2846	5238	0.8634	0.7749	0.0277	–	31.73	–	53.81	–	0.87		
		0.984	BNM05	0.197	0.002	0.004	2000	3395	0.8550	0.7740	0.0260	–	31.34	–	53.42	–	0.86		
		0.984	BNM10	0.394	0.002	0.004	1750	3372	0.8550	0.7740	0.0260	–	31.75	–	53.83	–	0.86		
		0.984	BNM25	0.984	0.004	0.005	700	2537	0.8550	0.7740	0.0260	–	31.50	–	53.58	–	0.86		
	16	0.787	RN05	0.197	0.0004	0.0012	3300	10683	0.7734	0.7659	0.0106	–	31.29	–	53.37	–	0.78		
		0.787	RN10	0.394	0.0004	0.0012	1500	9210	0.7734	0.7659	0.0106	–	31.29	–	53.37	–	0.78		
30	39.4	1.500	BN04	0.250	0.004	0.015	4500	7143	1.0872	2.1018	0.1401	–	32.66	–	54.73	–	1.39		
		1.575	BNM05	0.197	0.002	0.004	3000	6714	1.1232	2.1378	0.1702	–	34.07	–	56.14	–	1.44		
		1.575	BNM10	0.394	0.002	0.004	2950	7476	1.1233	2.1378	0.1702	–	35.48	–	57.55	–	1.44		
		1.575	BNM20	0.787	0.002	0.005	1845	5528	1.1232	2.1378	0.1702	–	33.58	–	55.65	–	1.44		

Temperature range	40° to 130° F (4.4° to 54.4° C)
IP rating	<b>40</b> (static) standard for 06, 10, 15, 20 sizes <b>69k</b> (static) standard for 22, 25, 30 sizes

### SIDE LOAD CONSIDERATIONS

The standard ERD rod-style actuator is not meant to be used in applications where side loading occurs. If side loading exists in the application consider the GD2 guided option.

Loads must be guided and supported. Loads should be aligned with the line of motion of the thrust rod.

Side loading will affect the life of the actuator.

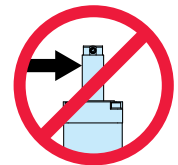

\*Longer stroke length modification available upon request.



# ERD – Electric Rod-Style Actuator



SIZE: ALL

## SPECIFICATIONS

### SPECIFICATIONS (metric measurement)

ERD SIZE	MAXIMUM STROKE*	SCREW DIA.	SCREW CODE	LEAD	LEAD ACCURACY	BACKLASH	MAXIMUM THRUST	DYNAMIC LOAD RATING	INERTIA			WEIGHT					WEIGHT (GD2 adder)		
									LMI	RP	Per 25mm	LMI (AL)	LMI (SS)	RP (AL)	RP (SS)	(SS adder)	Per 25mm	Base	Per Inch
mm	mm			mm/rev	mm/300mm	mm	N	N	kg-m <sup>2</sup> x 10 <sup>-6</sup>	kg-m <sup>2</sup> x 10 <sup>-6</sup>	kg-m <sup>2</sup> x 10 <sup>-6</sup>	kg	kg	kg	kg	kg	kg	kg	kg
06	203.2	6.35	SN02	12.70	0.13	0.18	89	NA	0.53	–	0.03	0.119	–	–	–	–	0.016	0.263	0.012
		6.35	SN04	6.35	0.13	0.18	89	NA	0.53	–	0.03	0.119	–	–	–	–	0.016	0.263	0.012
		6.35	SN16	1.60	0.13	0.18	89	NA	0.53	–	0.03	0.119	–	–	–	–	0.016	0.263	0.012
10	254.0	9.53	SN01	25.4	0.18		188	NA	0.64	–	0.18	0.186	–	–	–	1.034	0.031	0.466	0.028
		9.53	SN02	12.7	0.18		188	NA	0.64	–	0.18	0.186	–	–	–	1.034	0.031	0.466	0.028
		9.53	SN05	5.08	0.18		188	NA	0.64	–	0.18	0.186	–	–	–	1.034	0.031	0.466	0.028
		12.00	BNM05	5.00	0.87	0.13	445	1068	1.16	–	0.41	0.275	–	–	–	1.034	0.039	0.466	0.028
15	304.8	12.70	SN01	25.4	0.15	0.18	334	NA	3.04	61.48	0.50	0.489	–	1.919	3.520	2.618	0.057	1.042	0.043
		12.70	SN02	12.7	0.13	0.18	334	NA	3.04	61.48	0.50	0.489	–	1.919	3.520	2.618	0.057	1.042	0.043
		12.70	SN05	5.08	0.15	0.18	334	NA	3.04	61.48	0.50	0.489	–	1.919	3.520	2.618	0.057	1.042	0.043
	609.6	16.00	BNM05	5.00	0.87	0.13	890	2002	5.21	64.61	1.28	0.531	–	1.919	3.520	2.618	0.072	1.042	0.043
		16.00	BNM10	10.00	0.87	0.13	890	1779	5.21	64.61	1.28	0.531	–	1.919	3.520	2.618	0.072	1.042	0.043
20	609.6	25.00	BNM05	5.00	0.87	0.13	2224	4003	18.38	120.04	7.7	3.436	–	23 FRM	23 FRM	3.426	0.147	2.928	0.116
		25.00	BNM10	10.00	0.87	0.13	2224	4003	18.38	120.04	7.7	3.436	–	25.45 FRM	4.096 FRM	3.426	0.147	2.928	0.116
		20.00	BNM20	20.00	0.87	0.10	2224	11387	18.38	120.04	0.3073	3.436	–	2.744	4.286	3.426	0.147	2.928	0.116
22	1000	19.10	BN02	12.70	0.10	0.38	7117	12615	1.3036	1.6083	0.0252	-	5.01	-	9.15	-	0.20		
		19.10	BN05	5.08	0.08	0.38	4226	7224	1.3036	1.6083	0.0252	-	5.01	-	9.15	-	0.20		
		16.00	BNM05	5.00	0.05	0.10	4448	8710	1.2503	1.5550	0.0129	-	4.90	-	9.04	-	0.18		
		16.00	BNM10	10.00	0.05	0.10	4003	5400	1.2503	1.5550	0.0129	-	4.90	-	9.04	-	0.18		
		20.00	BNM20	20.00	0.10	0.10	4448	11387	1.3265	1.6312	0.0308	-	5.04	-	9.19	-	0.20		
	406	15.00	RN05	5.00	0.01	0.03	7562	35016	1.2383	1.5430	0.0097	-	4.89	-	9.04	-	0.18		
15.00		RN10	10.00	0.01	0.03	3781	30270	1.2383	1.5430	0.0097	-	4.89	-	9.04	-	0.18			
25	1000	25.40	BN01	25.40	0.102	0.05	3163	2500	2.5298	2.2703	0.0812	11.09	14.41	15.93	24.42	-	0.39		
		25.40	BN02	12.70	0.102	0.05	6330	5418	2.5298	2.2703	0.0812	11.07	14.39	15.91	24.41	-	0.39		
		25.40	BN04	6.35	0.102	0.05	12660	5238	2.5298	2.2703	0.0812	11.08	14.39	15.91	24.41	-	0.39		
		25.00	BNM05	5.00	0.051	0.10	8896	3395	2.5052	2.2679	0.0762	10.90	14.22	15.74	24.23	-	0.39		
		25.00	BNM10	10.00	0.051	0.10	7784	3372	2.5052	2.2679	0.0762	11.10	14.40	15.94	24.42	-	0.39		
		25.00	BNM25	25.00	0.102	0.13	3114	11285	2.5052	2.2679	0.0762	10.99	14.29	15.83	24.30	-	0.39		
	406	20.00	RN05	5.00	0.0102	0.03	14679	10683	2.2661	2.2440	0.0311	10.88	14.19	15.71	24.21	-	0.35		
		20.00	RN10	10.00	0.0102	0.03	6672	9210	2.2661	2.2440	0.0311	10.88	14.19	15.71	24.21	-	0.35		
30	1000	38.10	BN04	6.35	0.102	0.38	20017	7143	3.1856	6.1584	0.4105	11.50	14.81	16.34	24.83	-	0.63		
		40.00	BNM05	5.00	0.051	0.10	13345	6714	3.2911	6.2638	0.4987	12.14	15.45	16.98	25.47	-	0.65		
		40.00	BNM10	10.00	0.051	0.10	13122	7476	3.2911	6.2638	0.4987	12.78	16.09	17.62	26.11	-	0.65		
		40.00	BNM20	20.00	0.051	0.13	8207	24590	3.2911	6.2638	0.4987	11.92	15.23	16.75	25.24	-	0.65		

#### What Does IP67 mean?

The IP Code (or Ingress Protection Rating) consists of the letters IP followed by two digits and an optional letter. As defined in international standard IEC 60529, it classifies the degrees of protection provided against the intrusion of solid objects (including body parts like hands and fingers), dust, accidental contact, and water in electrical enclosures.

The test specifies a spray nozzle that is fed with 80°C water at 8–10MPa (80–100bar) and a flow rate of 14–16L/min. The nozzle is held 10–5 cm from the tested device at angles of 0°, 30°, 60° and 90° for 30s each. The test device sits on a turntable that rotates once every 12s (5rpm).

#### SOLIDS, FIRST DIGIT:

4	>1 mm	Most wires, screws, etc.
6	Dust tight	No ingress of dust; complete protection against solid object intrusion

#### LIQUIDS, SECOND DIGIT (static rating)

0	Not protected	
7	Immersion up to 1 m	Ingress of water in harmful quantity shall not be possible when the enclosure is immersed in water under defined conditions of pressure and time (up to 1 m of submersion).
9K	High pressure, high temp. wash-down	As above, plus ingress of water in harmful quantity shall not be possible when the enclosure is subject to high pressure, high temperature wash-down.

#### What Does IP69K mean?

German standard DIN 40050-9 extends the IEC 60529 rating system described above with an IP69K rating for high-pressure, high-temperature wash-down applications.[4] Such enclosures must not only be dust tight (IP6X), but also able to withstand high-pressure and steam cleaning.

The first digit indicates the level of protection that the enclosure provides against access to hazardous parts (e.g., electrical conductors, moving parts) and the ingress of solid foreign objects.

The second digit indicates the level of protection that the enclosure provides against harmful ingress of water.

# ERD – Electric Rod-Style Actuator

SIZE: ERD06, ERD10

PERFORMANCE



## CRITICAL SPEED CAPACITY

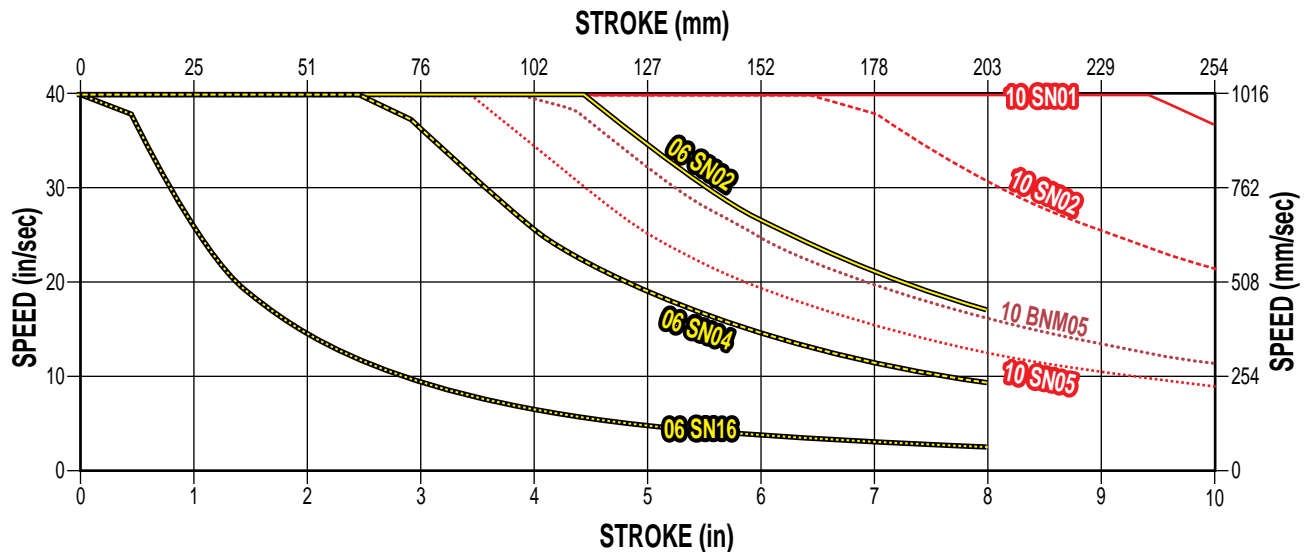

## PV LIMITS (ACME NUTS)

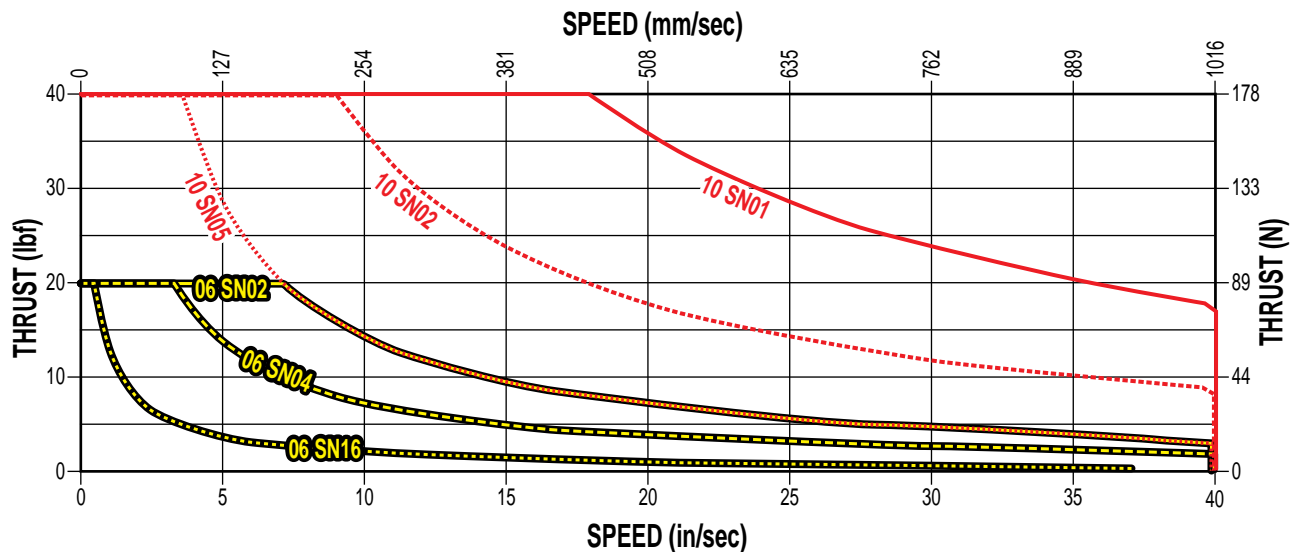

(Pressure Velocity of Acme Nut)

**PV LIMITS:** Any material which carries a sliding load is limited by heat buildup. The factors that affect heat generation rate in an application are the pressure on the nut in pounds per square inch and the surface velocity in feet per minute. The product of these factors provides a measure of the severity of an application.

$$P \times V \leq 0.1$$

$$\left( \frac{\text{Thrust}}{\text{(Max. Thrust Rating)}} \right) \times \left( \frac{\text{Speed}}{\text{(Max. Speed Rating)}} \right) \leq 0.1$$

# ERD – Electric Rod-Style Actuator



SIZE: ERD06, ERD10

## PERFORMANCE

### MAXIMUM THRUST vs STROKE

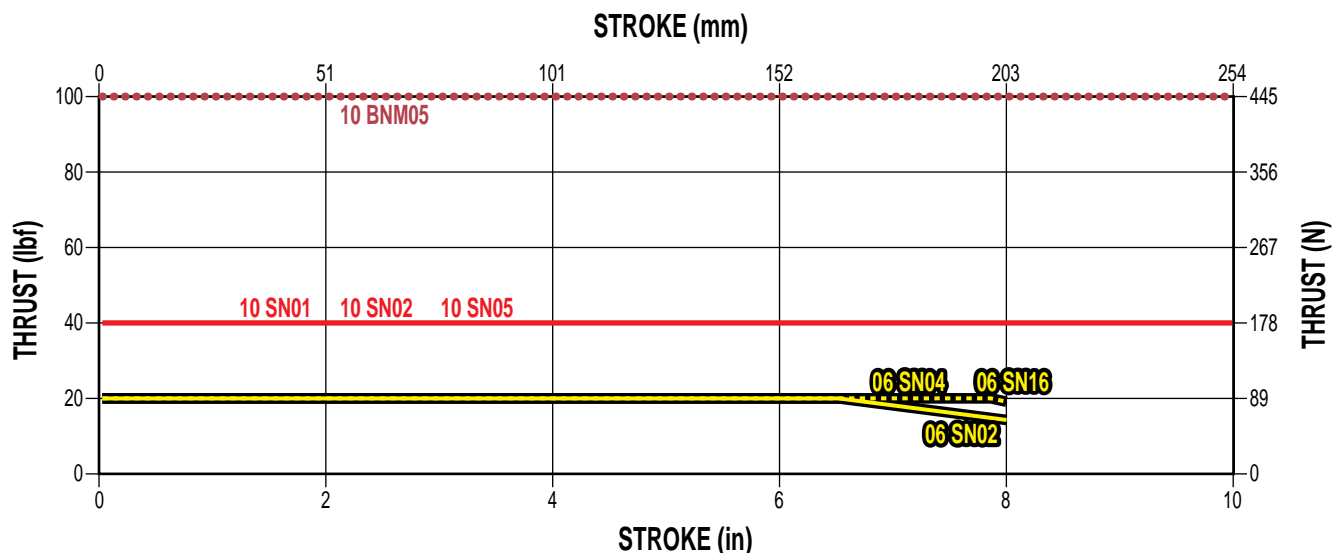

### SCREW LIFE (BALL NUTS)

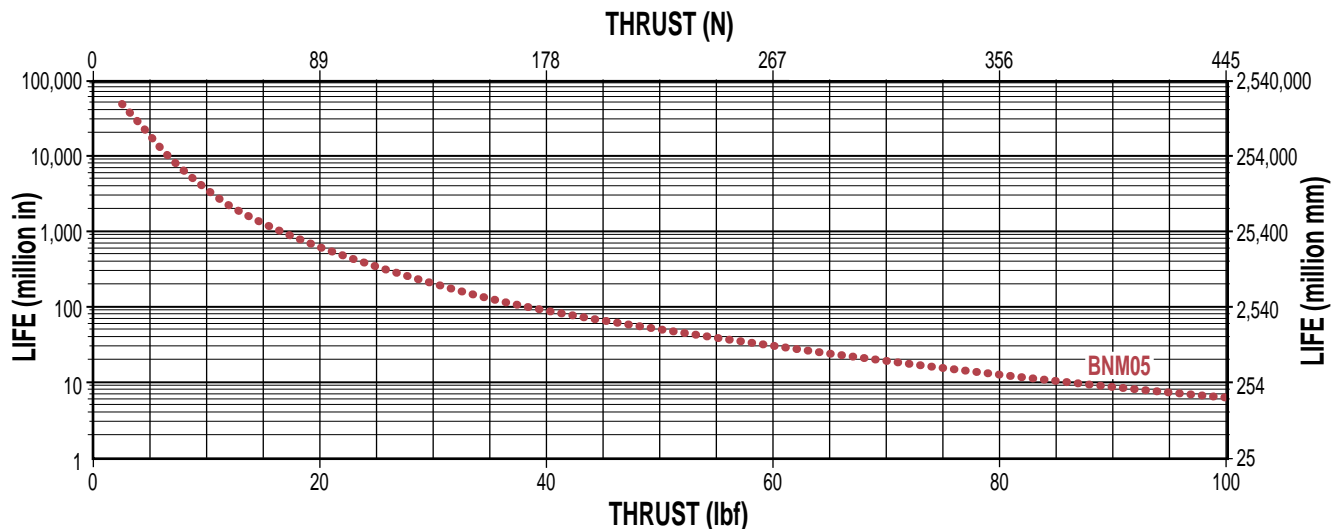

*NOTE: The  $L_{10}$  expected life of a ball screw linear actuator is expressed as the linear travel distance that 90% of properly maintained ball screw manufactured are expected to meet or exceed. This is not a guarantee and this graph should be used for estimation purposes only.*

The underlying formula that defines this value is:

$$L_{10} = \left(\frac{C}{F}\right)^3 \cdot \ell$$

Travel life in millions of inches, where:

- C** = Dynamic load rating (lbf)
- F** = Equivalent load (lbf)
- $\ell$  = Screw lead (in/rev)

Use the "Equivalent Load" calculation below, when the load is not constant throughout the entire stroke. In cases where there is only minor variation in loading, use greatest load for life calculations.

$$P_e = \sqrt[3]{\frac{\% (P_1)^3 + \% (P_2)^3 + \% (P_3)^3 + \% (P_n)^3}{100}}$$

Where:

- P<sub>e</sub>** = Equivalent load (lbs)
- P<sub>n</sub>** = Each increment at different load (lbs)
- %<sub>n</sub>** = Percentage of stroke at load increment

# ERD – Electric Rod-Style Actuator

SIZE: ERD15

PERFORMANCE



## CRITICAL SPEED CAPACITY

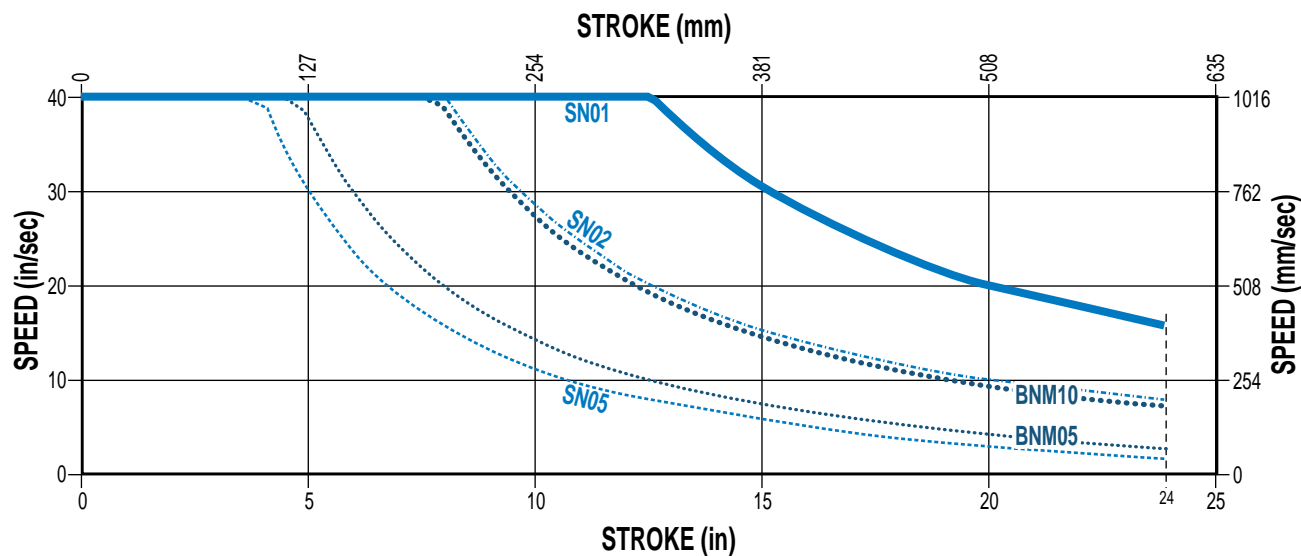

## PV LIMITS (ACME NUTS)

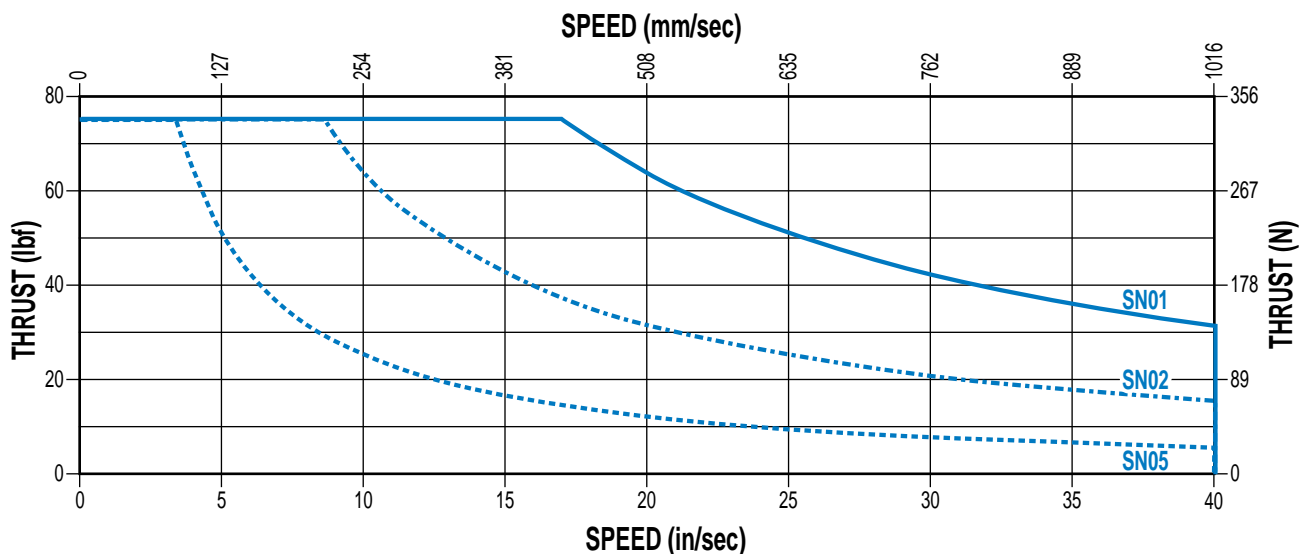

(Pressure Velocity of Acme Nut)

**PV LIMITS:** Any material which carries a sliding load is limited by heat buildup. The factors that affect heat generation rate in an application are the pressure on the nut in pounds per square inch and the surface velocity in feet per minute. The product of these factors provides a measure of the severity of an application.

$$P \times V \leq 0.1$$

$$\left( \frac{\text{Thrust}}{\text{(Max. Thrust Rating)}} \right) \times \left( \frac{\text{Speed}}{\text{(Max. Speed Rating)}} \right) \leq 0.1$$

# ERD – Electric Rod-Style Actuator



SIZE: ERD15

PERFORMANCE

## MAXIMUM THRUST vs STROKE

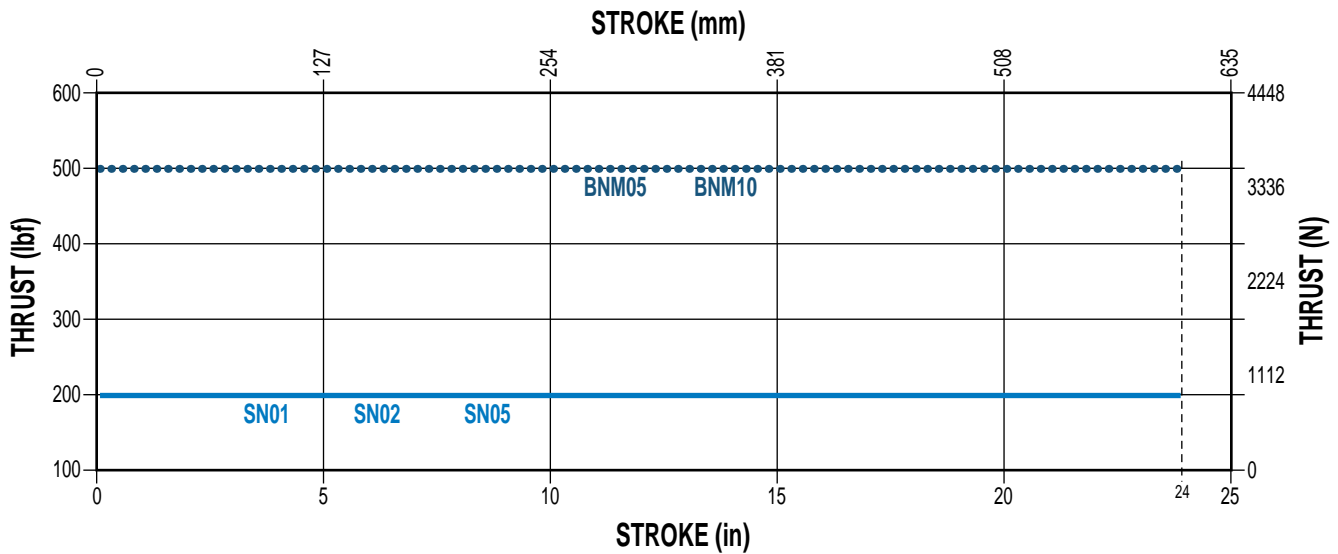

## SCREW LIFE (BALL NUTS)

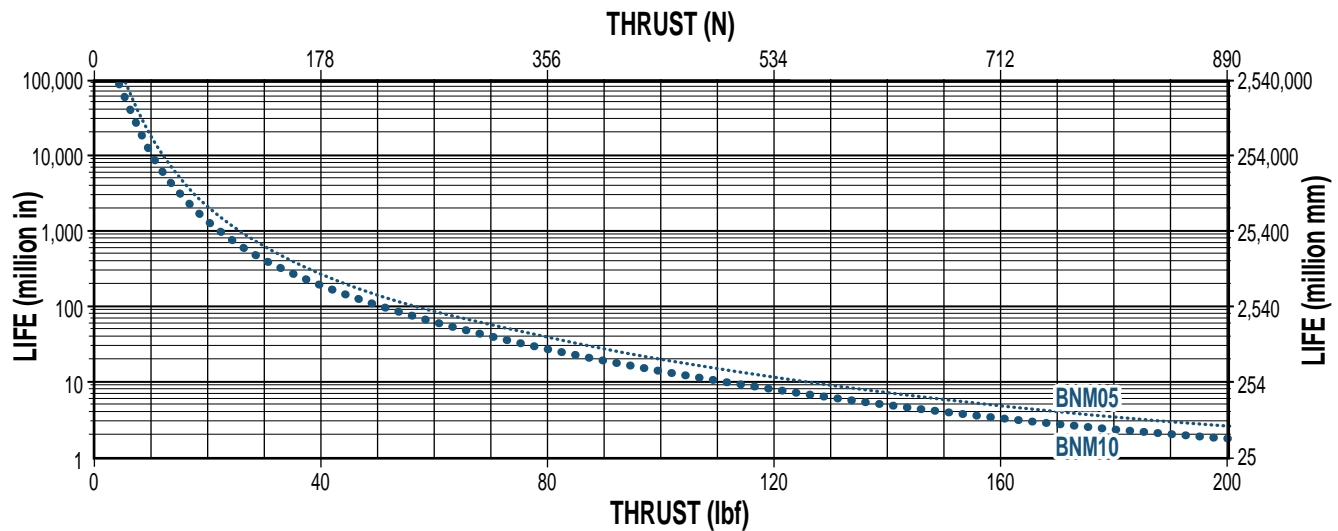

*NOTE: The  $L_{10}$  expected life of a ball screw linear actuator is expressed as the linear travel distance that 90% of properly maintained ball screw manufactured are expected to meet or exceed. This is not a guarantee and this graph should be used for estimation purposes only.*

The underlying formula that defines this value is:

$$L_{10} = \left(\frac{C}{F}\right)^3 \cdot \ell =$$

Travel life in millions of inches, where:

- C** = Dynamic load rating (lbf)
- F** = Equivalent load (lbf)
- $\ell$**  = Screw lead (in/rev)

Use the "Equivalent Load" calculation below, when the load is not constant throughout the entire stroke. In cases where there is only minor variation in loading, use greatest load for life calculations.

$$P_e = \sqrt[3]{\frac{\% (P_1)^3 + \% (P_2)^3 + \% (P_3)^3 + \% (P_n)^3}{100}}$$

Where:

- $P_e$**  = Equivalent load (lbs)
- $P_n$**  = Each increment at different load (lbs)
- $\%_n$**  = Percentage of stroke at load increment

# ERD – Electric Rod-Style Actuator



SIZE: **ERD20**

**PERFORMANCE**

## CRITICAL SPEED CAPACITY

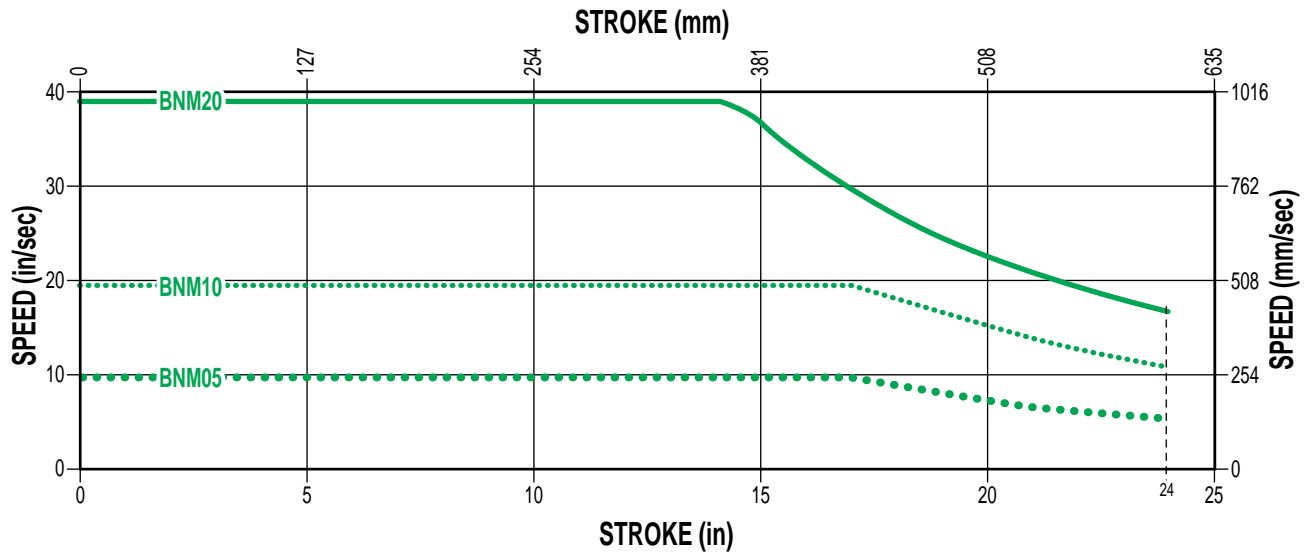

## MAXIMUM THRUST vs STROKE

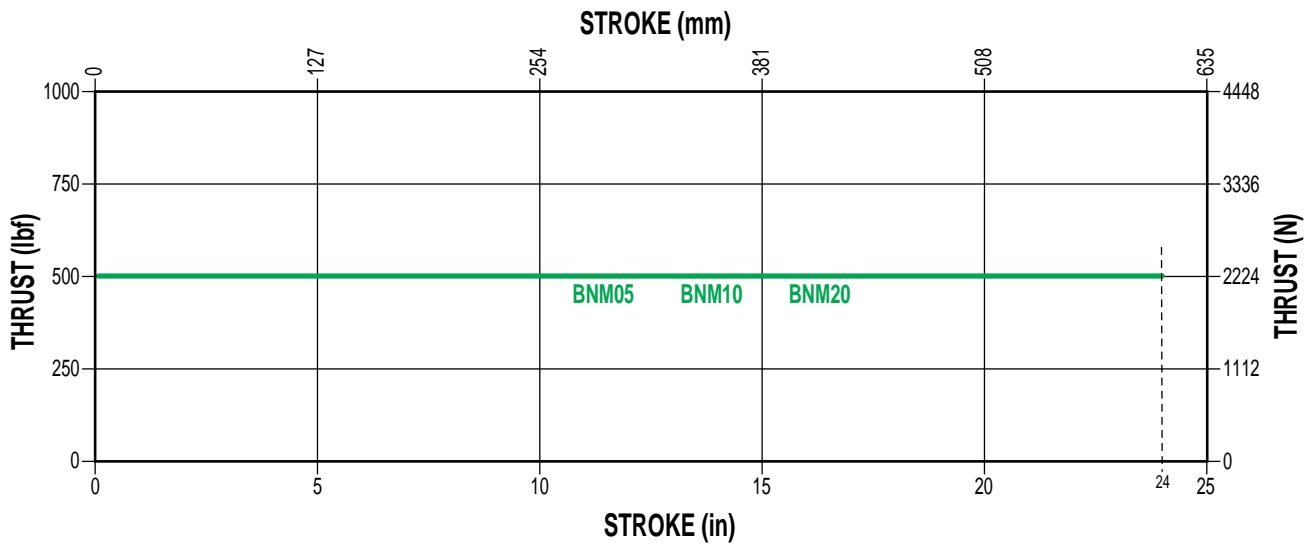

## SCREW LIFE

**NOTE:** See  $L_{10}$  expected life calculation on page ERD\_13

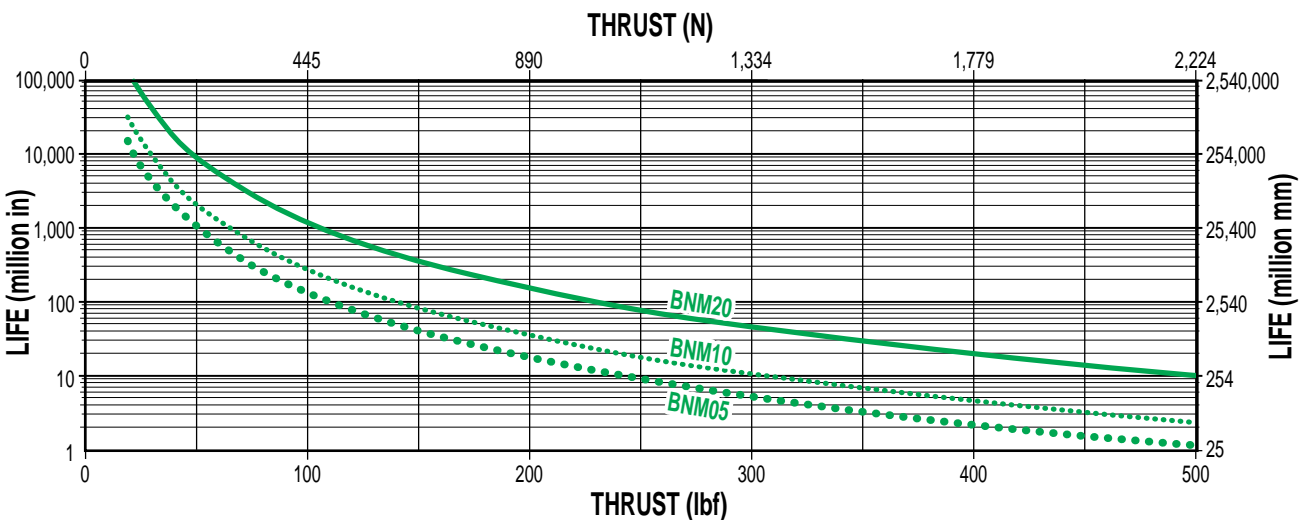

# ERD – Electric Rod-Style Actuator

SIZE: ERD22

PERFORMANCE



## CRITICAL SPEED CAPACITY

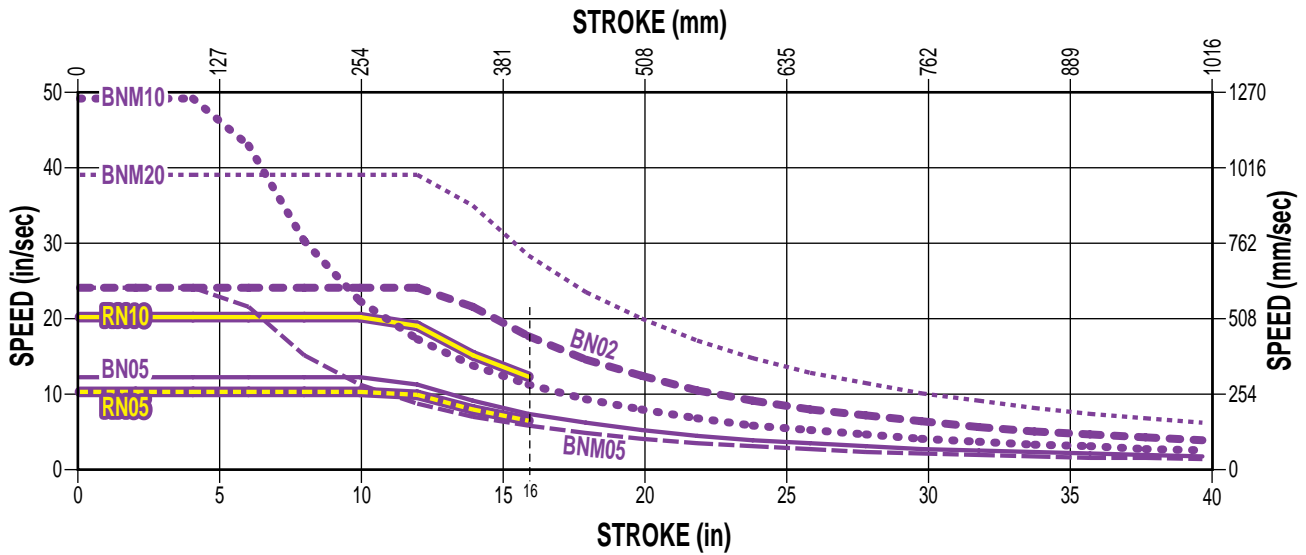

## MAXIMUM THRUST vs STROKE

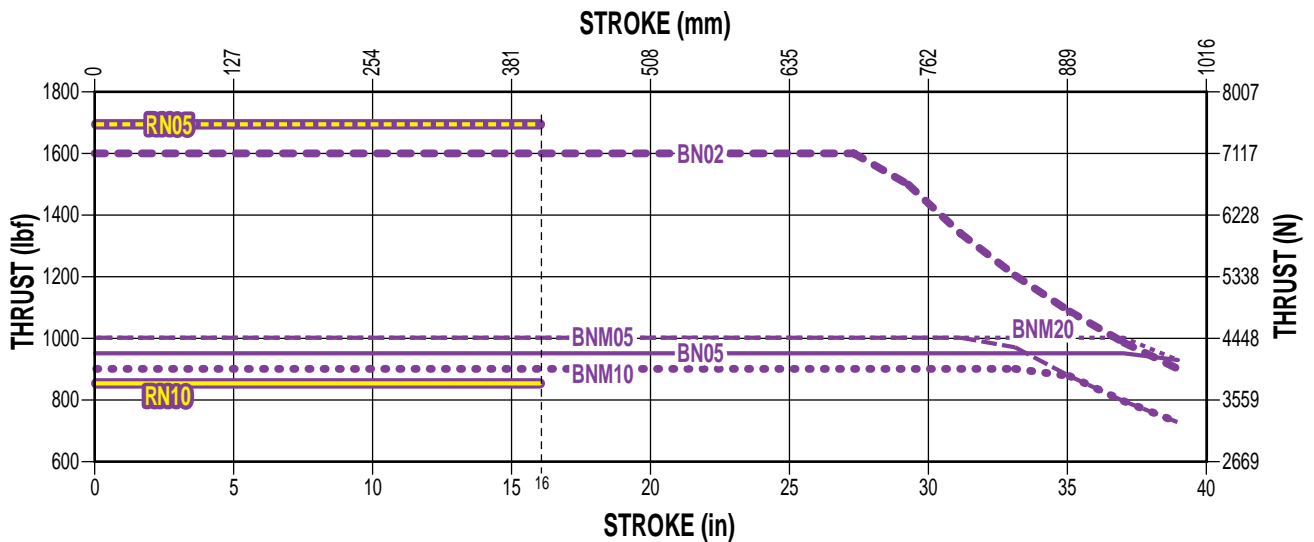

## SCREW LIFE

NOTE: See  $L_{10}$  expected life calculation on page ERD\_13

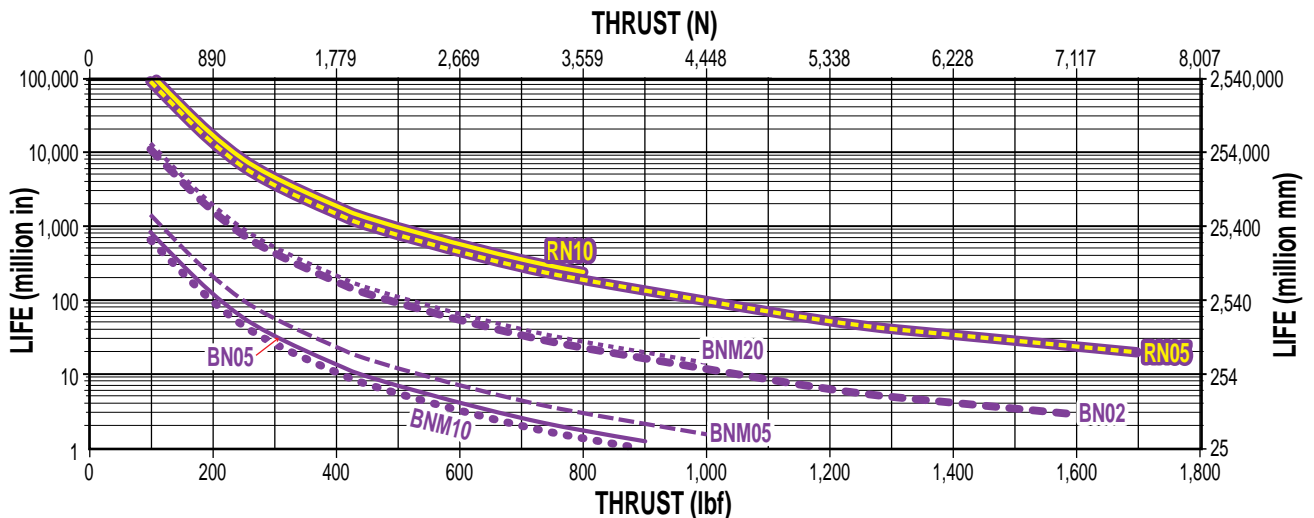

# ERD – Electric Rod-Style Actuator



SIZE: **ERD25**

**PERFORMANCE**

## CRITICAL SPEED CAPACITY

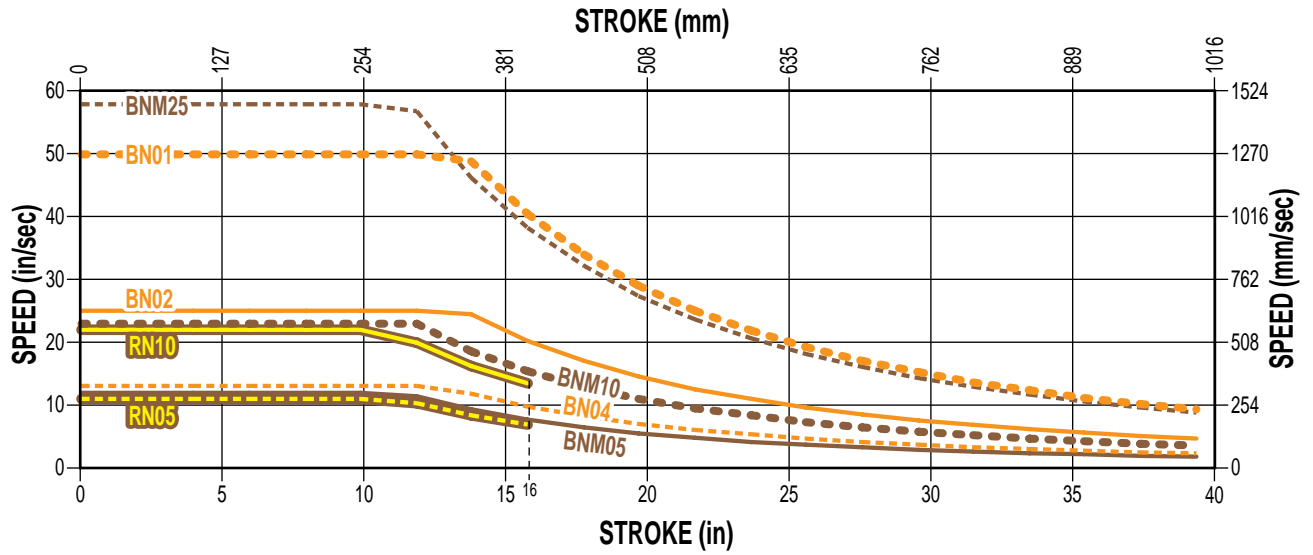

## MAXIMUM THRUST vs STROKE

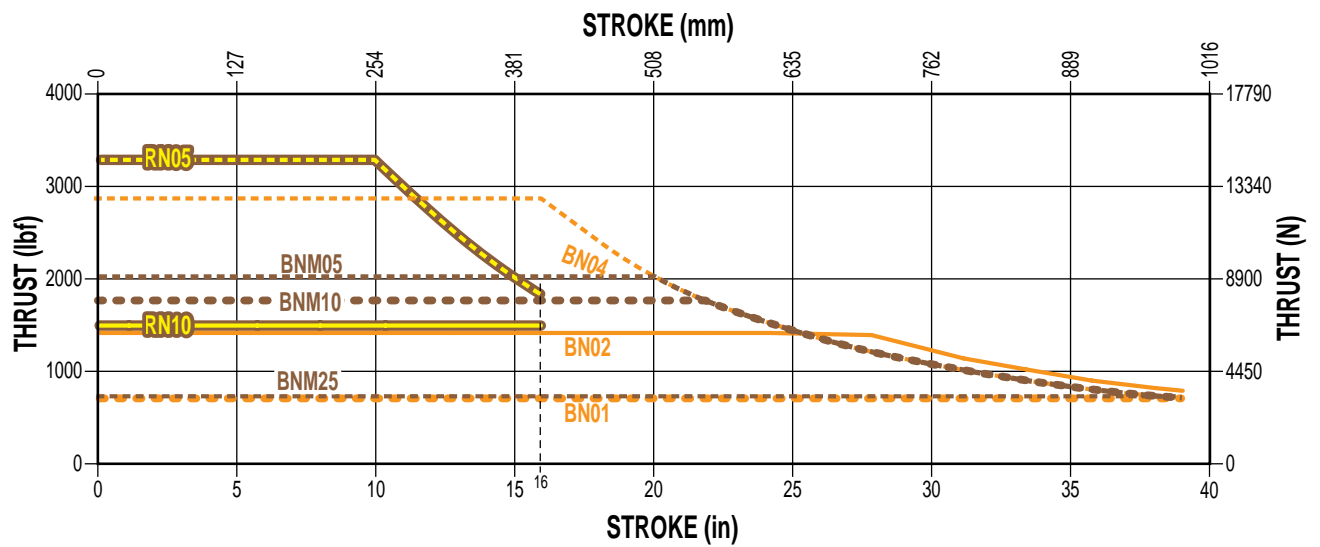

## SCREW LIFE

NOTE: See L<sub>10</sub> expected life calculation on page ERD\_13

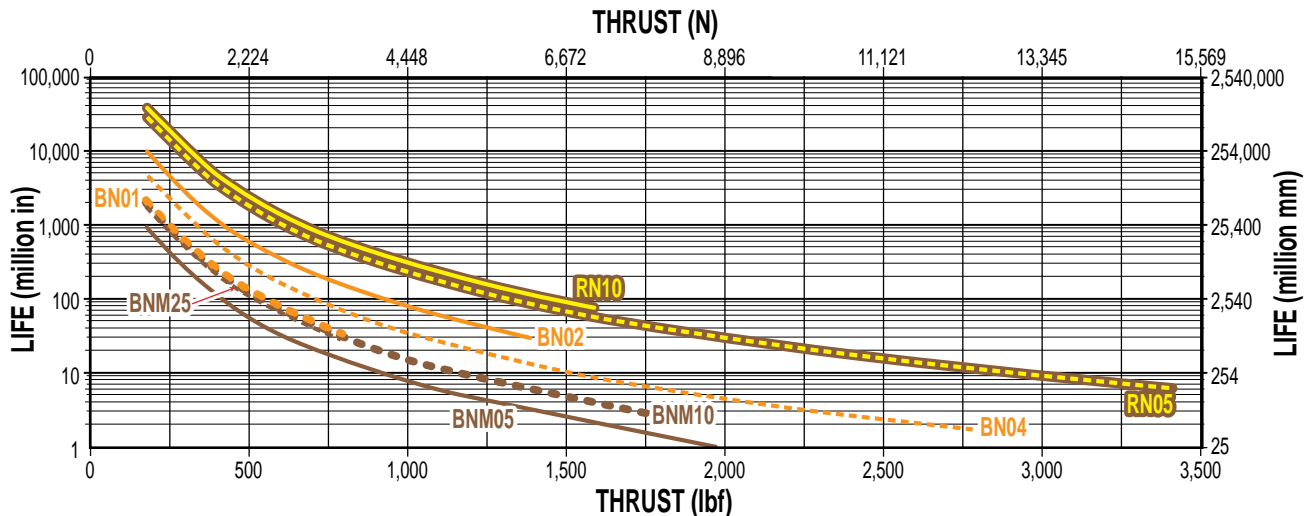



# ERD – Electric Rod-Style Actuator



SIZE: **ERD30**

**PERFORMANCE**

## CRITICAL SPEED CAPACITY

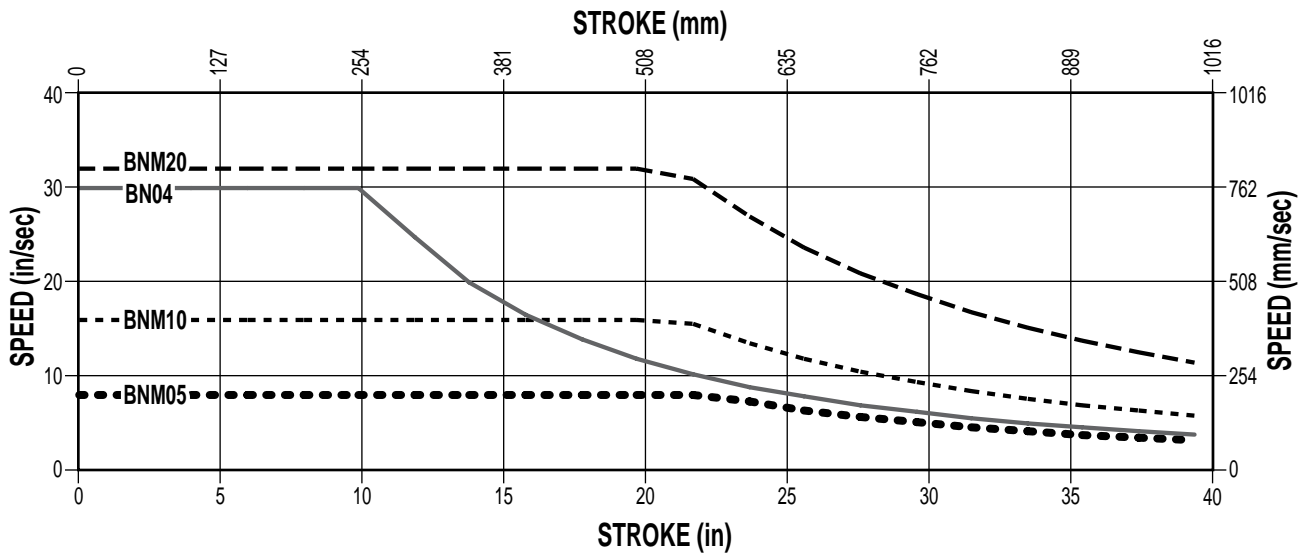

## MAXIMUM THRUST vs STROKE

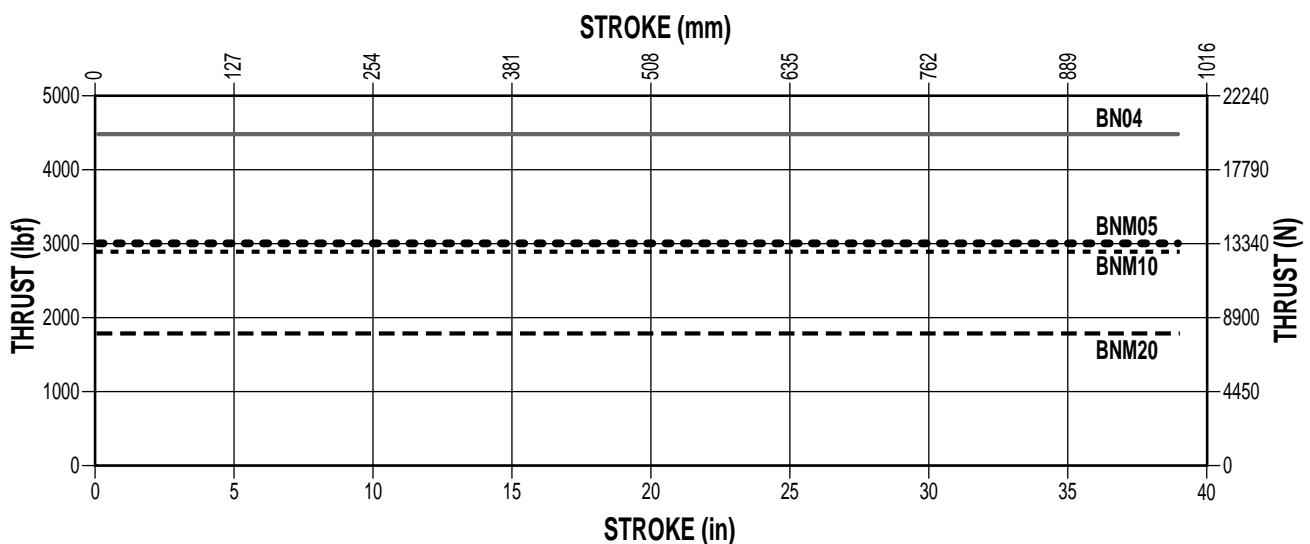

## SCREW LIFE

NOTE: See  $L_{10}$  expected life calculation on page ERD\_13

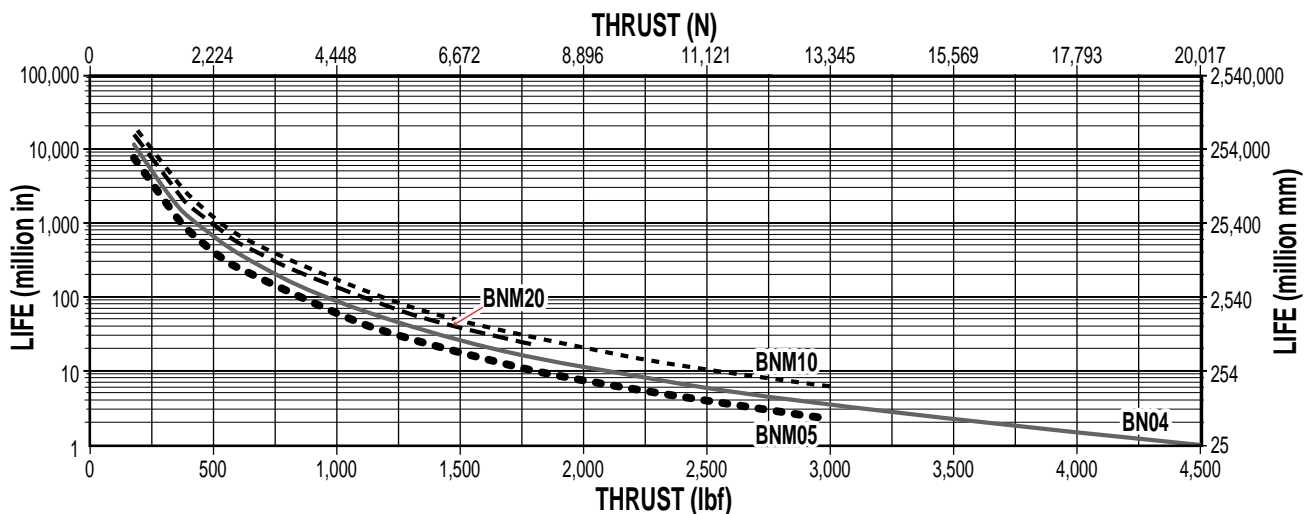

# ERD – Electric Rod-Style Actuator



OPTION: **GD2 – GUIDED ERD**

**PERFORMANCE**

## LOAD VS EXTENDED LENGTH

**06, 10, 15**

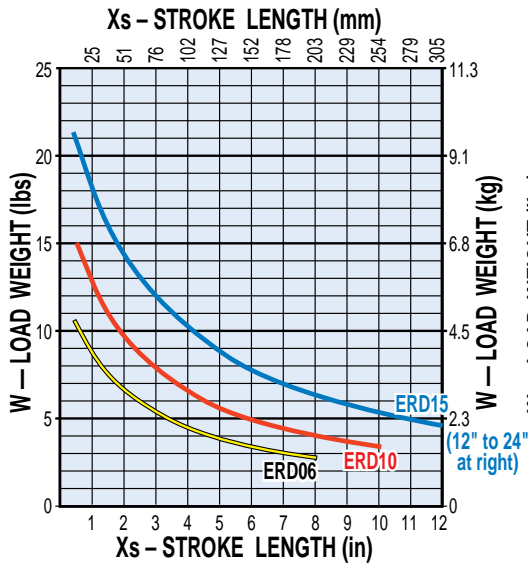

**15, 20**

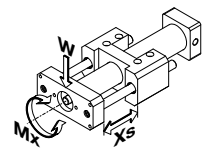
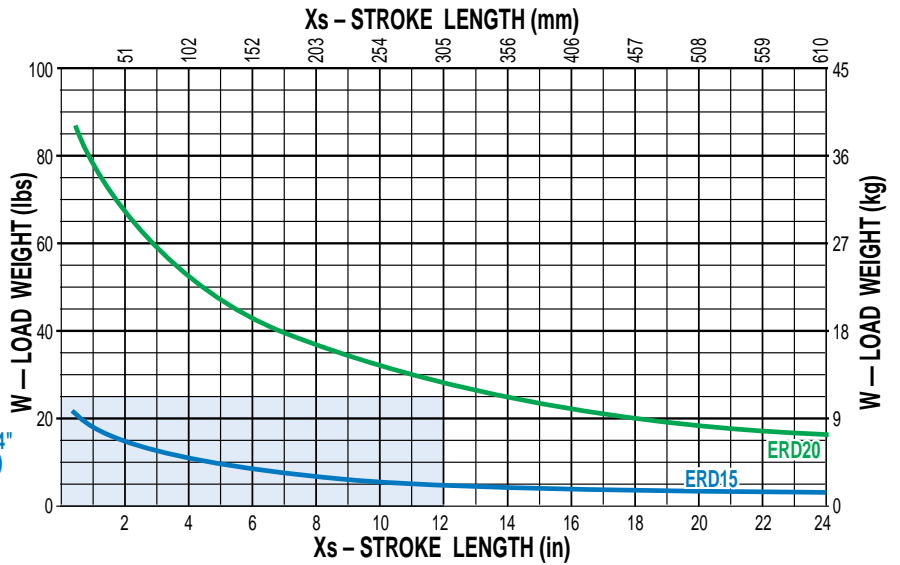

## BENDING MOMENTS

**06, 10, 15**

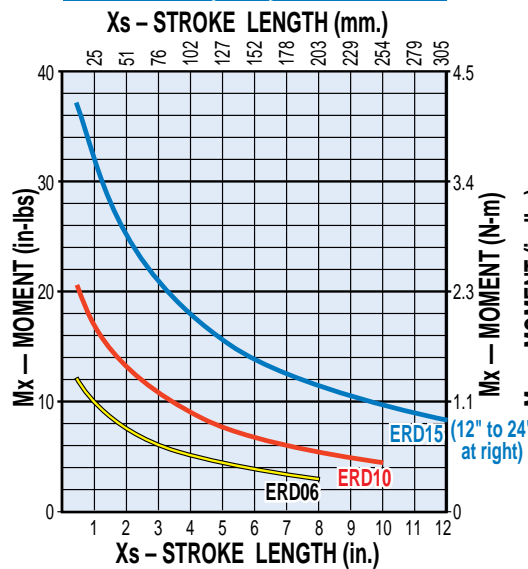

**15, 20**

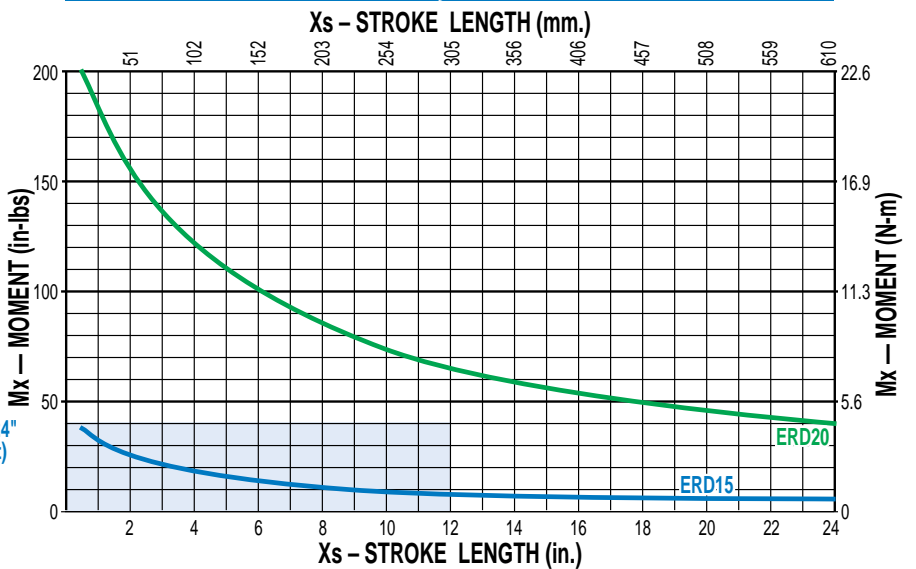

# ERD – Electric Rod-Style Actuator

OPTION: **GD2 – GUIDED ERD**

**PERFORMANCE**

SIZING SOFTWARE  
AVAILABLE AT [WWW.TOLOMATIC.COM](http://WWW.TOLOMATIC.COM)

**ACTUATOR**

**SIZING**



## GUIDE ROD DEFLECTION

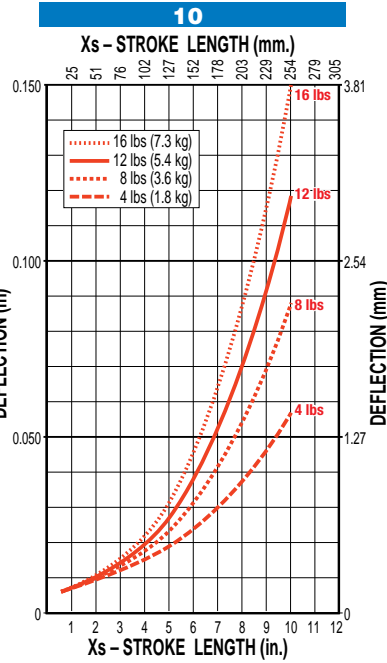
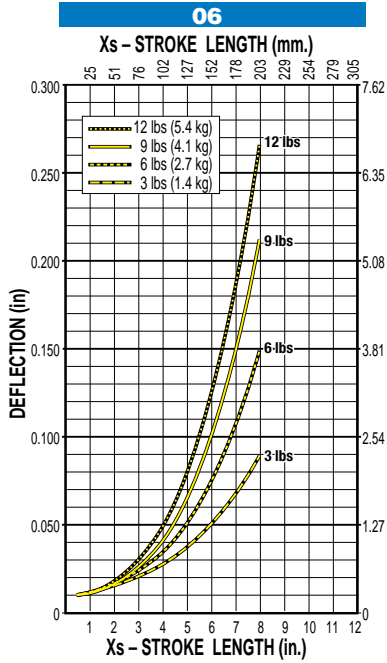

**NOTE:** Deflection is measured at the tooling plate. Excessive deflection may impact actuator life. Contact Tolomatic for assistance

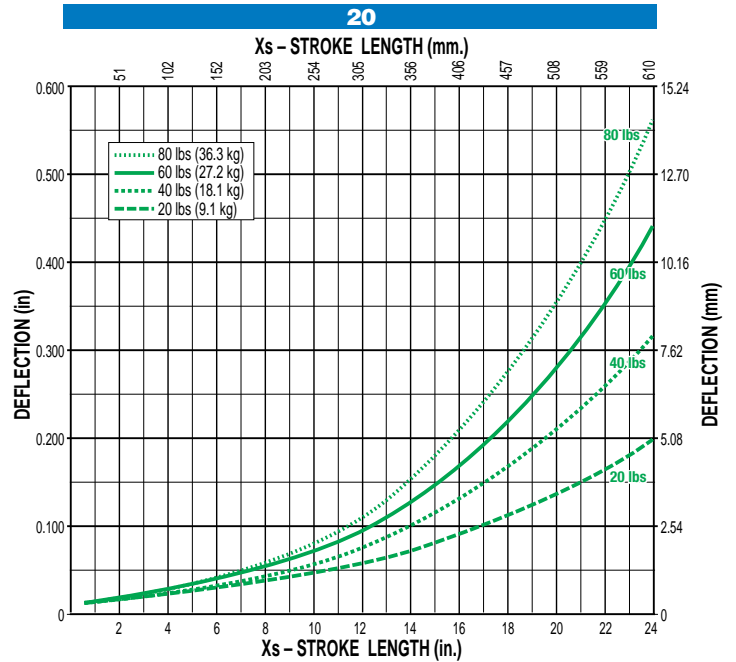
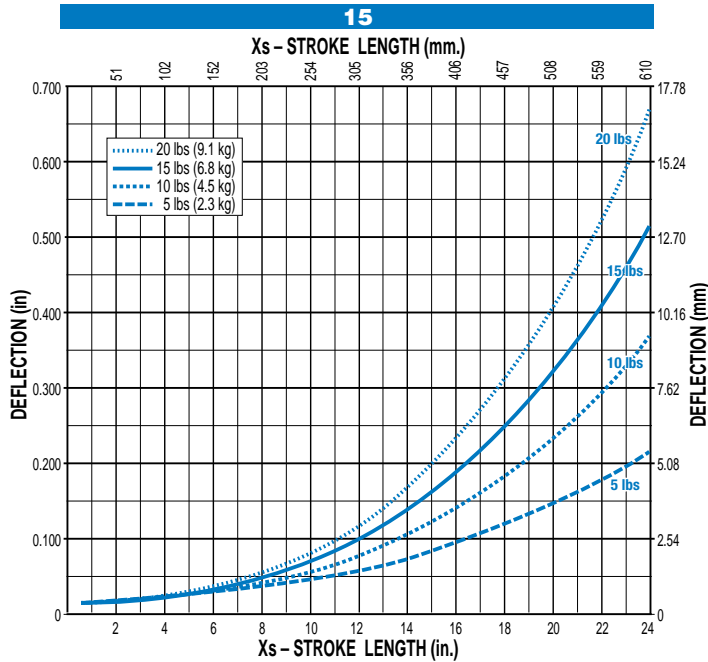
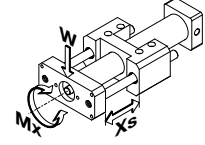



# ERD – Electric Rod-Style Actuator

SIZE: 06, 10, 15, 20

**DIMENSIONS**  3D CAD available at [www.tolomatic.com](http://www.tolomatic.com)

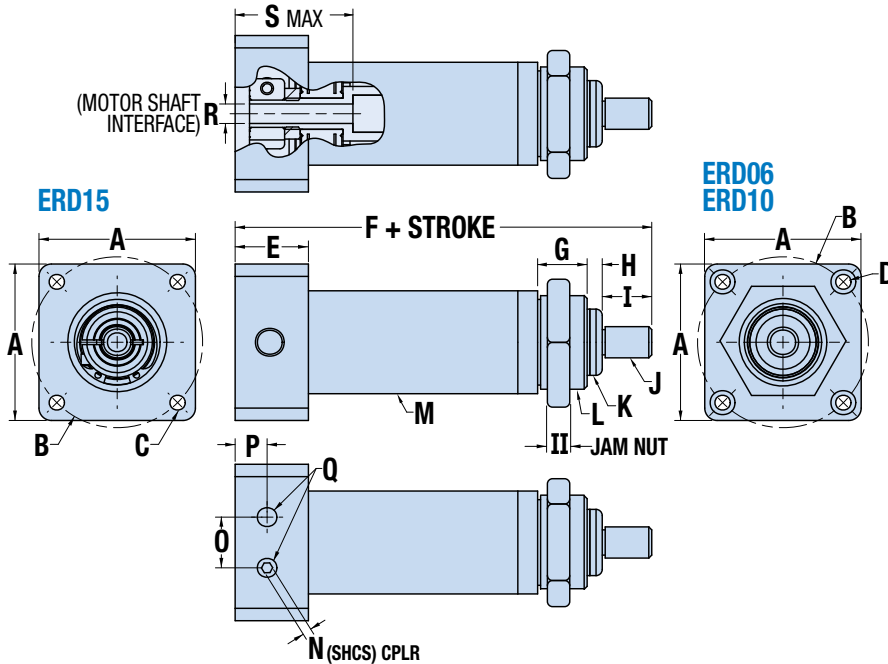
## ACTUATOR



 \*This dimension is determined by motor choice.

		ERD06	ERD10	ERD15	ERD20
<b>A</b>	in	1.125	1.580	2.220*	*
	mm	28.58	40.13	56.39*	*
<b>B</b>	in	Ø1.287	Ø1.725	Ø2.625*	*
	mm	Ø32.69	Ø43.82	Ø66.68*	*
<b>C</b>	in	-	-	-	*
	mm	-	-	M4 x 0.7*	*
<b>D</b>	in	Ø.136	Ø.154	-	*
	mm	Ø3.45	Ø3.91	-	*

		ERD06	ERD10	ERD15	ERD20
<b>E</b>	in	1.400	0.740	0.850*	*
	mm	35.56	18.80	21.59*	*
<b>F</b>	in	3.88	4.20	5.40*	*
	mm	98.5	106.7	137.2*	*
<b>G</b>	in	0.500	0.500	0.600	0.750
	mm	12.70	12.70	15.24	18.75
<b>H</b>	in	0.153	0.153	0.153	0.153
	mm	3.89	3.89	3.89	3.89
<b>I</b>	in	0.375	0.500	0.750	0.750
	mm	9.53	12.70	19.05	19.05
<b>J</b>	in	-	-	-	-
	mm	M6 x 1.0	M8 x 1.25	M12 x 1.75	M16 x 2.0
<b>K</b>	in	Ø.443	Ø.686	Ø1.041	1.323
	mm	Ø11.25	Ø17.42	Ø26.40	33.60
<b>L</b>	in	-	-	-	-
	mm	M16 x 1.5	M24 x 1.5	M34 x 1.5	M44 x 1.5
<b>II</b>	in	0.236	0.236	0.315	0.315
	mm	6.00	6.00	8.00	8.00
<b>M</b>	in	Ø.686	Ø1.040	Ø1.638	Ø2.051
	mm	Ø17.42	Ø26.42	Ø41.61	52.20
<b>N</b>	in	0.098	0.098	0.098*	*
	mm	2.50	2.50	2.50*	*
<b>O</b>	in	0.512	0.512	0.512	0.920
	mm	13.00	13.00	13.00	23.37
<b>P</b>	in	0.264	0.323	0.298*	*
	mm	6.71	8.20	7.57*	*
<b>Q</b>	in	(2) M4 x 0.7 ‡.10	(2) M6 x 1.0 ‡.31	(2) M6 x 1.0 ‡.50	(2) M6 x 1.0 ‡.50
	mm	(2) M4 x 0.7 ‡2.5	(2) M6 x 1.0 ‡7.9	(2) M6 x 1.0 ‡12.7	(2) M6 x 1.0 ‡12.7
<b>R</b>	in	Ø.197	Ø.197	Ø.250*	*
	mm	Ø5.00	Ø5.00	Ø6.35*	*
<b>S</b>	in	1.100	1.100	1.250*	*
	mm	27.94	27.94	31.75*	*

## IP67 - IP69K OPTION DIMENSIONS

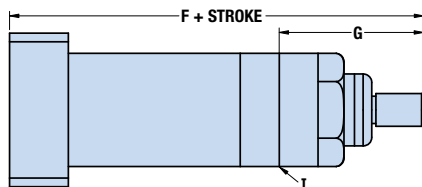

IP67 (static rating) option replaces the Jam Nut (II in table above)

### IP67 OPTION

		ERD06	ERD10	ERD15	ERD20
<b>F</b>	in	4.59	4.79	6.00*	8.06*
	mm	116.6	121.8	152.4*	204.8*
<b>G</b>	in	1.744	1.739	2.09	2.85
	mm	44.30	44.17	53.0	72.5
<b>I</b>		Surface for mounting options			

### IP69K OPTION

		ERD06	ERD10	ERD15	ERD20
<b>F</b>	in	NA	NA	6.49	8.06*
	mm	NA	NA	164.8	204.8*
<b>G</b>	in	NA	NA	2.59	2.85
	mm	NA	NA	65.7	72.5
<b>I</b>		Surface for mounting options			

 \*Dimension shown is with Tolomatic AMS1xx motor hardware YMH option will determine this dimension.

# ERD – Electric Rod-Style Actuator

SIZE: 06, 10, 15, 20

**DIMENSIONS**  3D CAD available at [www.tolomatic.com](http://www.tolomatic.com)

## FFG - FRONT FLANGE

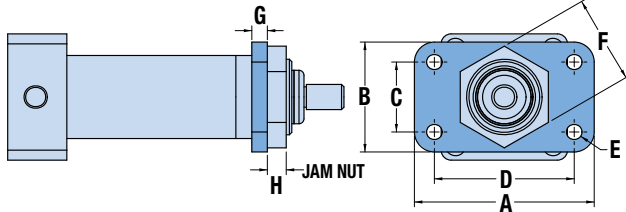

		ERD06	ERD10	ERD15	ERD20
A	in	1.750	2.250	2.500	3.500
	mm	44.45	57.15	63.50	88.90
B	in	1.000	1.375	1.750	2.250
	mm	25.40	34.93	44.45	57.15
C	in	0.500	0.875	1.250	1.750
	mm	12.70	22.23	31.75	44.45
D	in	1.250	1.750	2.000	3.000
	mm	31.75	44.45	50.80	76.20

		ERD06	ERD10	ERD15	ERD20
E	in	0.154	0.194	0.221	0.281
	mm	03.91	04.93	05.61	07.14
F	in	0.709	1.102	1.575	1.890
	mm	18.00	28.00	40.00	48.08
G	in	0.194	0.194	0.194	0.194
	mm	4.93	4.93	4.93	4.93
H	in	0.236	0.236	0.315	0.315
	mm	6.00	6.00	8.00	8.00

## FM2 - FOOT MOUNT

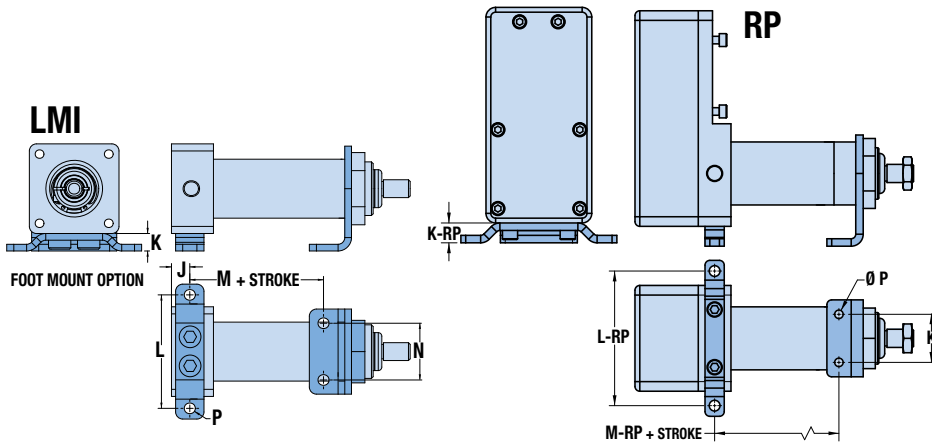

		ERD06	ERD10	ERD15	ERD20
J	in	0.264	0.323	0.298	—
	mm	6.71	8.20	7.57	—
K	in	0.259	0.308	0.406	0.569
	mm	6.58	7.82	10.31	14.46
L	in	1.750	2.00	2.600	3.250
	mm	44.45	50.80	66.04	82.55
M	in	2.270	2.357	3.165	3.200
	mm	57.66	59.87	80.39	81.28
N	in	0.625	1.00	1.250	1.25
	mm	15.88	25.4	31.75	31.75
P	in	0.154	0.194	0.221	0.281
	mm	03.91	04.93	05.61	07.14
K-RP	in	—	—	0.516	0.500
	mm	—	—	13.11	12.70
L-RP	in	—	—	3.500	3.675
	mm	—	—	88.90	93.35
M-RP	in	—	—	3.038	2.636
	mm	—	—	77.15	66.95

## TRR - TRUNNION MOUNT / RP 23 FRAME

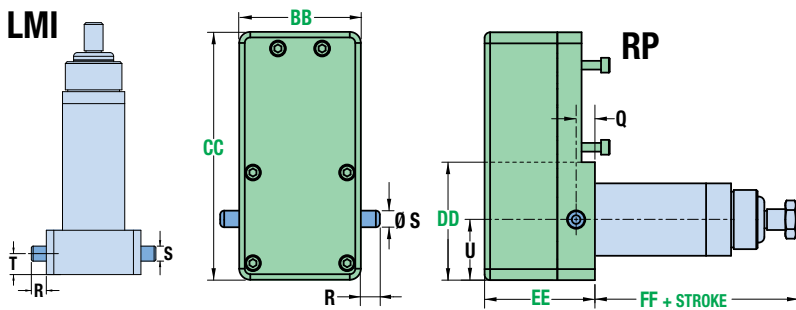

## PCD - REAR CLEVIS / RP 34 FRAME

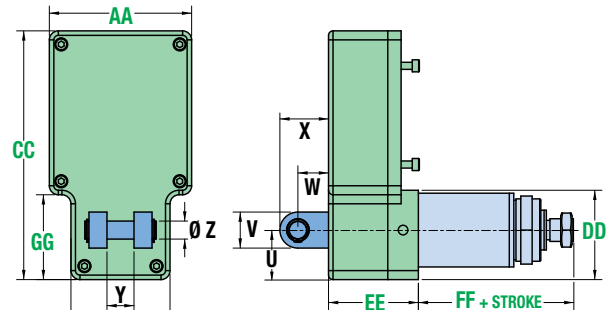

		ERD06	ERD10	ERD15	ERD20
Q	in	—	—	0.425	0.425
	mm	—	—	10.78	10.78
R	in	0.250	0.250	0.430	0.750
	mm	6.35	6.35	10.92	19.05
S	in	0.1878 / 0.1876	0.2503 / 0.2501	0.3753 / 0.3751	0.6245 / 0.6240
	mm	04.770 / 04.765	06.358 / 06.353	09.533 / 09.528	015.862 / 015.850
T	in	1.221	0.350	0.425*	—
	mm	31.01	8.89	10.80*	—
U	in	—	—	1.375	1.375
	mm	—	—	34.93	34.93

		ERD15	23 FRM	ERD20	34 FRM
AA	in	—	—	3.950	—
	mm	—	—	100.33	—
BB	in	2.750	2.750	2.750	—
	mm	69.85	69.85	69.85	—
CC	in	5.605	5.605	6.905	—
	mm	142.37	142.37	175.39	—
DD	in	2.312	2.543	2.480	—
	mm	58.72	64.59	62.99	—
EE	in	2.495	2.495	2.495	—
	mm	63.38	63.38	63.38	—
FF	in	4.553	4.302	4.302	—
	mm	115.05	109.28	109.28	—
GG	in	—	—	2.355	—
	mm	—	—	59.82	—

		ERD15	ERD20
U	in	1.375	1.375
	mm	34.93	34.93
V	in	1.000	1.000
	mm	25.40	25.40
W	in	0.850	0.850
	mm	21.59	21.59
X	in	1.350	1.350
	mm	34.29	34.29
Y	in	0.750	0.750
	mm	19.05	19.05
Z	in	.4995 / .4990	.4995 / .4990
	mm	12.687 / 12.675	12.687 / 12.675

# ERD – Electric Rod-Style Actuator

SIZE: 06, 10, 15, 20

**DIMENSIONS**  3D CAD available at [www.tolomatic.com](http://www.tolomatic.com)

## GD2 – GUIDED ERD

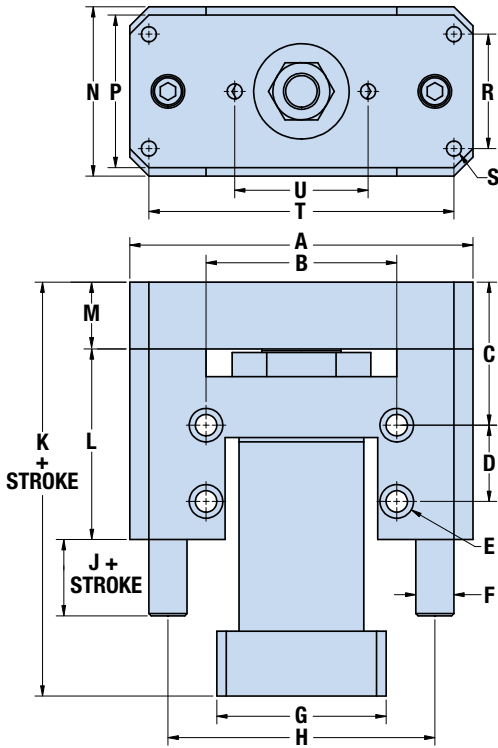

**GUIDED ERD WITH IP67 OPTION**  
ERD STROKE IS REDUCED BY DIMENSION "V"

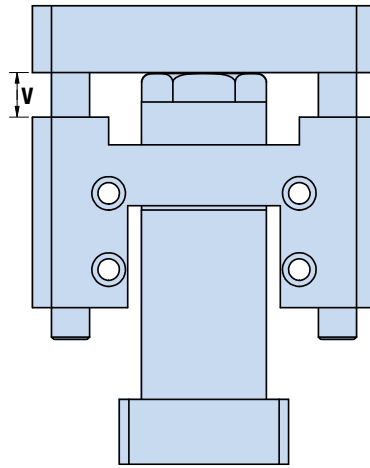

		ERD06	ERD10	ERD15	ERD20
A	in	3.000	3.500	4.500	5.900
	mm	76.20	88.90	114.30	149.86
B	in	1.625	2.000	2.500	3.250
	mm	41.28	50.80	63.50	82.55
C	in	1.125	1.250	1.875	2.500
	mm	28.58	31.75	47.63	63.50
D	in	1.000	1.000	1.000	2.00
	mm	25.40	25.40	25.40	50.8
E Ø	in	0.194	0.221	0.281	0.344
		⌊0.31 x 0.19⌋	⌊0.38 x 0.22⌋	⌊0.44 x 0.28⌋	⌊0.56 x 0.34⌋
	mm	4.93	5.61	7.14	8.74
		⌊7.9 x 4.8⌋	⌊9.7 x 5.6⌋	⌊11.2 x 7.1⌋	⌊13.5 x 8.6⌋
F Ø	in	0.250	0.375	0.500	0.750
	mm	6.35	9.53	12.70	19.05
G	in	1.125	1.580	2.220*	*
	mm	28.58	40.13	56.39*	*
H	in	2.250	2.750	3.500	4.625
	mm	57.15	69.85	88.90	117.48
J	in	1.000	1.000	1.000	1.500
	mm	25.40	25.40	25.40	38.10
K	in	3.910	4.244	5.428*	*
	mm	99.31	107.80	137.87*	*
L	in	2.000	2.000	2.500	5.000
	mm	50.80	50.80	63.50	127.00
M	in	0.500	0.625	0.875	1.000
	mm	12.70	15.88	22.23	25.40
N	in	1.125	1.580	2.220	2.400
	mm	28.58	40.13	56.39	60.96
P	in	1.000	1.500	2.000	2.300
	mm	25.40	38.10	50.80	58.42
R	in	0.625	1.000	1.500	1.500
	mm	15.88	25.40	38.10	38.10
S	in	–	–	–	–
	mm	M4x0.7	M5x0.8	M6x1.0	M8x1.25
T	in	2.625	3.000	4.000	5.000
	mm	66.68	76.20	101.60	127.00
U	in	1.000	1.375	1.750	2.250
	mm	25.40	34.93	44.45	57.15
V	in	0.716	0.587	0.585	1.200
	mm	18.19	14.91	14.86	30.47

## SS2 – STAINLESS-STEEL BODY WITH PROTECTIVE MOTOR COVER AND IP69K UPGRADE (IP67 for ERD10)

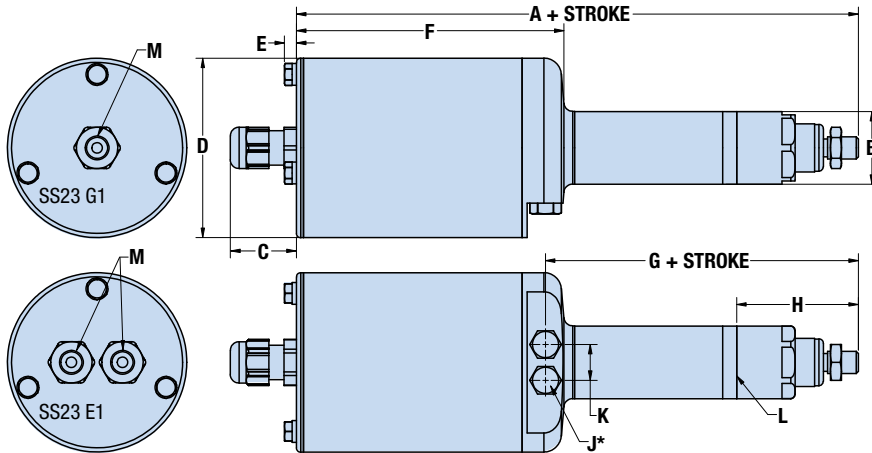

		ERD10	ERD15	ERD20
A	in	8.03	11.130	12.26
	mm	204.0	282.70	311.4
B	in	1.040	1.638	2.051
	mm	26.42	41.61	52.10
C	in	0.945	0.945	0.945
	mm	24.00	24.00	24.00
D	in	2.563	3.504	3.504
	mm	65.10	89.00	89.00

		ERD10	ERD15	ERD20
E	in	0.173	0.207	0.207
	mm	4.39	5.27	5.27
F	in	3.976	5.314	6.758
	mm	100.99	134.98	171.64
G	in	4.471	5.660	6.488
	mm	113.56	143.76	164.80
H	in	1.739	2.088	2.853
	mm	44.17	53.04	72.48
J*	in	–	–	–
	mm	M6 x 1.0	M6 x 1.0	M6 x 1.0

 \*This dimension is determined by motor choice.

NOTE: ERD\_ SS2 10 = IP67; 15 & 20 = IP69K

⊗ SS2 is not available for the 06, 22, 25, 30 size

		ERD10	ERD15	ERD20
K	in	0.512	0.512	0.920
	mm	13.00	13.00	23.37
L	Surface for mounting options			

M	Encoder		Available cable exit options:
	Code	Code	
	SS21	G1,E1	
SS22	G1,E1	no cord grips M20 x 1.5 tapped hole	
SS23	G1	1 cord grip (motor, no encoder)	
	E1	2 cord grips (motor, with encoder)	

\*Unit ships standard with hex bolts in these tapped holes  
NOTE: IP67 is a static rating

# ERD – Electric Rod-Style Actuator

SIZE: 22, 25, 30

**DIMENSIONS**  3D CAD available at [www.tolomatic.com](http://www.tolomatic.com)

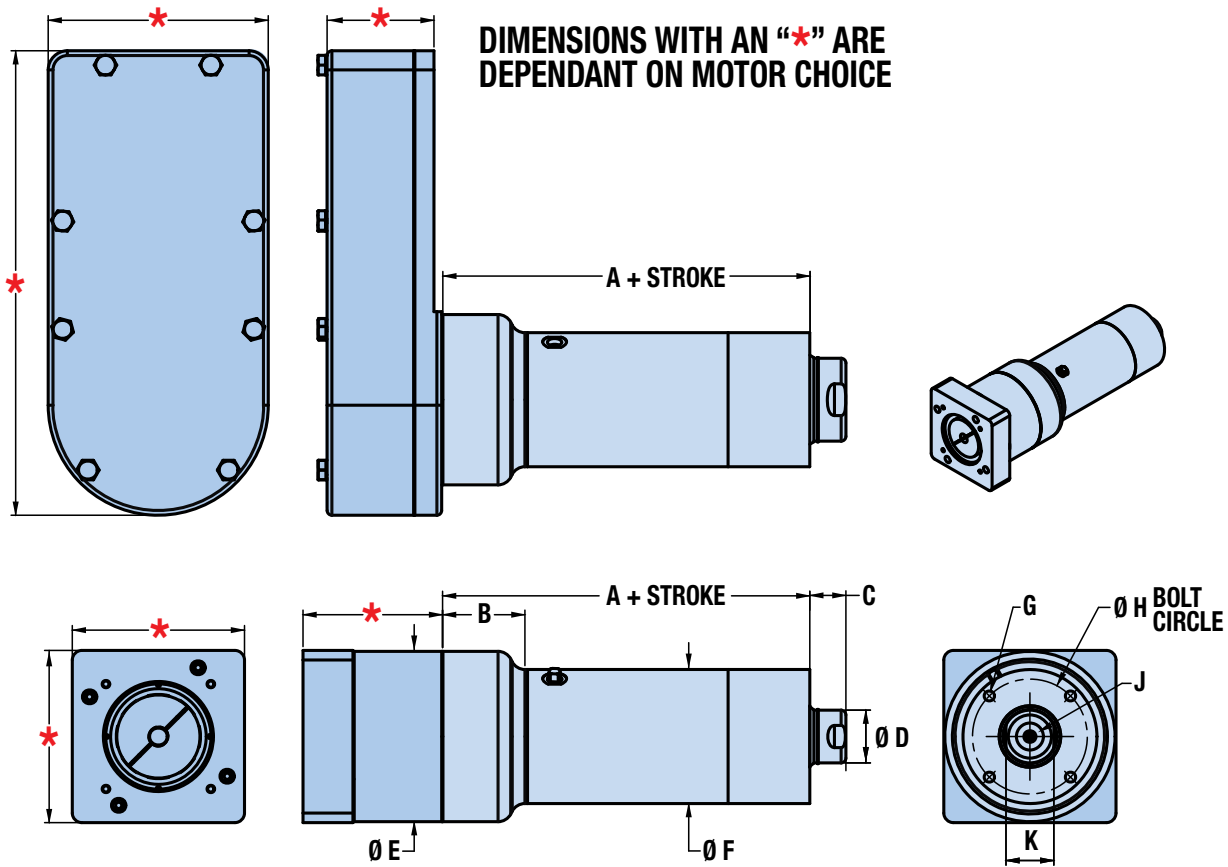

		A	B	C	D	Ø E	Ø F	G	Ø H	J	K
ERD22	in	7.375	1.688	0.70	1.102	2.95	2.24	–	1.791	–	1.000
	mm	187.33	42.88	17.8	27.99	74.9	56.9	M6 x 1.0 - 6H $\downarrow$ 12.0 (.47")	45.49	M12 x 1.25 $\downarrow$ 33.0 (.88")	25.40
ERD25	in	9.596	2.152	0.94	1.378	4.45	3.50	–	3.000	–	1.250
	mm	243.74	54.66	23.9	35.00	113.0	88.9	M8 x 1.25 - 6H $\downarrow$ 16.0 (.63")	76.20	M20 x 1.5 $\downarrow$ 25.4 (1.00")	31.75
ERD30	in	9.596	2.152	0.94	2.165	4.45	3.50	–	3.000	–	2.000
	mm	243.74	54.66	23.9	54.99	113.0	88.9	M8 x 1.25 - 6H $\downarrow$ 16.0 (.63")	76.20	M27 x 2.0 $\downarrow$ 33.0 (1.30")	50.80

## FFG OPTION

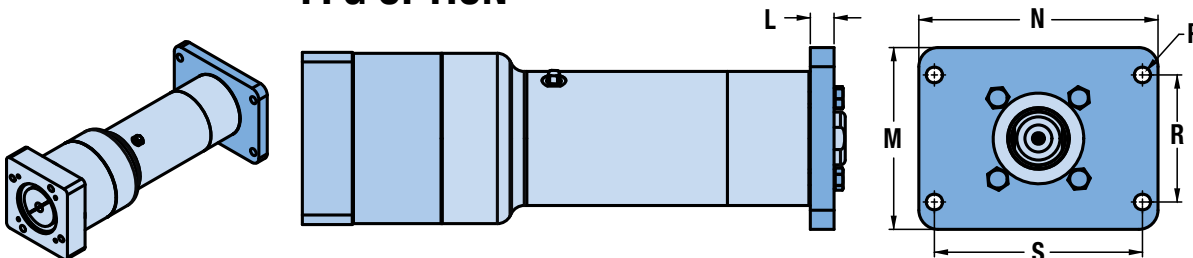

		L	M	N	P	R	S
ERD22	in	0.40	2.75	3.88	0.28	2.00	3.00
	mm	10.2	69.9	98.6	7.1	50.8	76.2
ERD25	in	0.62	4.75	6.25	0.42	3.32	5.44
	mm	15.7	120.7	158.8	10.7	84.3	138.2
ERD30	in	0.62	4.75	6.25	0.42	3.32	5.44
	mm	15.7	120.7	158.8	10.7	84.3	138.2

# ERD – Electric Rod-Style Actuator

SIZE: 22, 25, 30

**DIMENSIONS**  3D CAD available at [www.tolomatic.com](http://www.tolomatic.com)

## FM2 OPTION

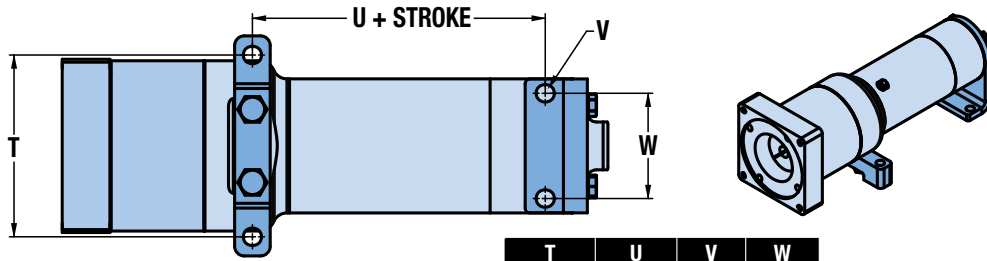

		T	U	V	W
ERD22	in	3.50	5.71	0.280	1.75
	mm	88.9	145.0	7.11	44.5
ERD25	in	4.75	7.65	0.472	2.75
	mm	120.7	194.3	11.99	69.9
ERD30	in	4.75	7.65	0.472	2.75
	mm	120.7	194.3	11.99	69.9

## TRR OPTION

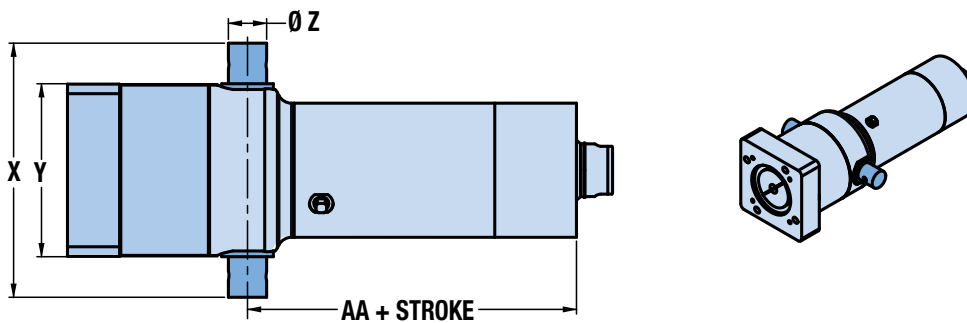

		X	Y	Ø Z	AA	
ERD22	in	4.318	3.058	0.630	0.629	6.625
	mm	109.68	77.67	16.00	15.95	168.28
ERD25	in	6.640	4.520	1.000	0.999	8.596
	mm	168.66	114.81	25.39	25.36	218.34
ERD30	in	6.640	4.520	1.000	0.999	8.596
	mm	168.66	114.81	25.39	25.36	218.34

## HYG1 OPTION

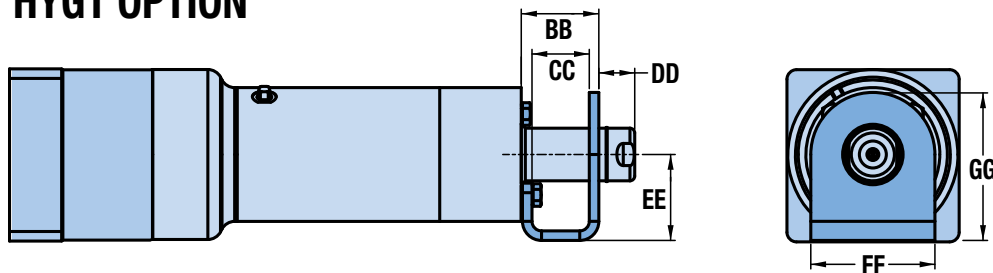

		BB	CC	DD	EE	FF	GG
ERD22	in	1.63	1.10	0.50	2.00	2.24	3.12
	mm	41.4	27.9	12.7	50.8	56.9	79.2
ERD25	in	2.03	1.50	0.94	2.25	3.25	3.88
	mm	51.6	38.1	23.9	57.2	82.6	98.6
ERD30	in	2.03	1.50	0.94	2.25	3.25	3.88
	mm	51.6	38.1	23.9	57.2	82.6	98.6



# ERD – Electric Rod-Style Actuator

## ALTERNATIVE MOTOR DIMENSIONS 3D CAD available at [www.tolomatic.com](http://www.tolomatic.com)

### MOTOR DIMENSIONS – NEMA MOTOR MOUNT

The ERD 06, 10 & 15 sizes are designed to accommodate NEMA standard stepper and servo motors.

ACTUATOR	SIZE
ERD06	NEMA11
ERD10	NEMA17
ERD15	NEMA23

The only limiting factors are the motor shaft diameter and length. NEMA standard motors from the companies in the table at right have been found to be compatible with the ERD actuator.  \*NOT a complete listing)

#### ERD Compatible NEMA Motor Suppliers\*

Anaheim Automation
Animatics
Applied Motion Products
Automation Direct
Cool Muscle
Electrocraft
Fastech
IMS / Scheider Electric
JVL
LIN Engineering
Nippon Pulse Motor
Omega
Oriental Motor
Parker
Sanyo Denki
+ Others

 When any motor has been selected for use with the ERD actuator it is important to confirm the motor is compatible with the dimensions in the table below.

			ERD06	ERD10	ERD15
MOTOR SHAFT	LENGTH	MIN.	0.50	0.50	0.50
		MAX.	1.100	1.100	1.250
	DIAMETER	MIN.	0.197	0.197	0.250
		MAX.	0.910	1.220	1.856
BOLT HOLE	CIRCLE	MIN.	1.287	1.725	2.625
	SPACING	MIN.	0.910	1.220	1.856
MOTOR PILOT	DIAMETER MAX.	MIN.	0.980	0.980	1.550
		MAX.	2.29	3.30	3.30
	HEIGHT MAX.	MIN.	0.090	0.130	0.130
		MAX.	2.29	3.30	3.30

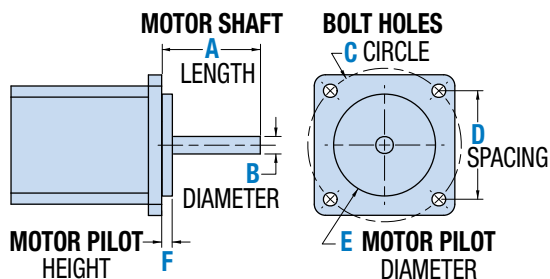

### MOTOR CHOICES - YOUR MOTOR HERE

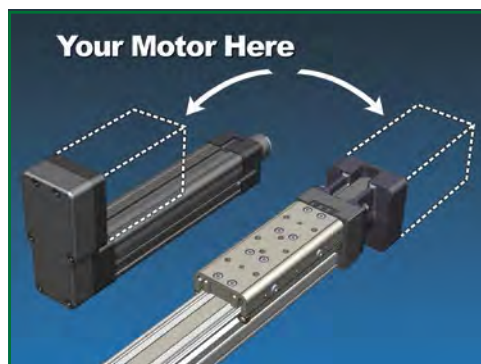

The ERD 15, 20, 22, 25 & 30 sizes utilize Tolomatic's YMH (Your Motor Here) program. See [www.tolomatic.com/ymh](http://www.tolomatic.com/ymh) or consult Tolomatic sales at 1-800-328-2174 for details.

#### CUSTOM MOTOR MOUNTS. 15 DAYS.

- Select a high-performance Tolomatic electric actuator and we'll provide a motor-specific interface for YOUR motor. With our online database, you can select from over 60 motor manufacturers and hundreds of models.

Visit [www.tolomatic.com/ymh](http://www.tolomatic.com/ymh) today to find your motor/actuator match!

# ERD – Electric Rod-Style Actuator

SIZE: ALL

**SWITCHES**



ERD actuators offer a wide range of sensing choices. There are 6 switch choices: reed, solid state PNP (sourcing) or solid state NPN (sinking); normally open; with flying leads or quick-disconnect.

Commonly used for end-of-stroke positioning, these switches allow clamp-on installation anywhere along the entire actuator length. The internal magnet, located on the thrust tube, is a standard feature. Switches can be installed in the field at any time.

Switches are used to send digital signals to PLC (programmable logic controller), TTL, CMOS circuit or other controller device. Switches contain reverse polarity protection. Solid state QD cables are shielded; shield should be terminated at flying lead end.

All switches are CE rated, IP67 rated and are RoHS compliant. Switches feature bright red or green LED signal indicators.



	Order Code	Part Number	Lead	Switching Logic	Power LED	Signal LED	Operating Voltage	**Power Rating (Watts)	Switching Current (mA max.)	Current Consumption	Voltage Drop	Leakage Current	Temp. Range	Shock / Vibration	IP Rating
REED	<b>R</b> <b>Y</b>	2190-9082	5m	SPST Normally Open	—	Red	5 - 240 AC/DC	**10.0	100mA	—	3.0 V max.	—	14 to 158°F	30 G / 9 G	67
	<b>R</b> <b>K</b>	2190-9083	QD*												
SOLID STATE	<b>T</b> <b>Y</b>	2190-9088	5m	PNP (Sourcing) Normally Open	—	Green	5 - 30 VDC	**3.0	200mA	8 mA @ 24V	1.0 V max.	0.01 mA max.	[-10 to 70°C]	50 G / 9 G	
	<b>T</b> <b>K</b>	2190-9089	QD*												
	<b>K</b> <b>Y</b>	2190-9090	5m	NPN (Sinking) Normally Open	—	Red									
	<b>K</b> <b>K</b>	2190-9091	QD*												

\*QD = Quick-disconnect      Enclosure classification IEC 529 IP67 (NEMA 6)

CABLES: Robotic grade, oil resistant polyurethane jacket, PVC insulation

**⚠️ \*\*WARNING:** Do not exceed power rating (Watt = Voltage x Amperage). Permanent damage to sensor will occur.

## SWITCH INSTALLATION - FIELD REPLACEMENT INSTRUCTIONS

**STEP 1:**  
Loosen screw and nut.

**STEP 2:**  
Place sensor and wrap the band around the ERD cylinder. Position the hook with the nearest hole on the band and mark the hole with a permanent marker.

**STEP 3:**  
Remove mounting assembly. Cut the band at the nearest edge of the next hole. (The one that's furthest away from the mounting head.)

**STEP 4:**  
Replace the sensor and mounting assembly. Wrap the band and put the chosen hole on the hook. Position the switch and tighten. Tighten nut for steadying.

# ERD – Electric Rod-Style Actuator

SIZE: ALL

SWITCHES

## WIRING DIAGRAMS

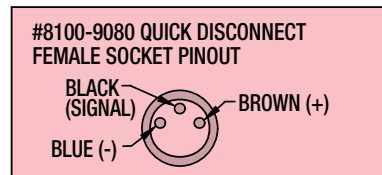
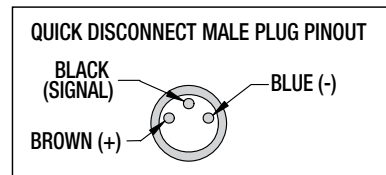
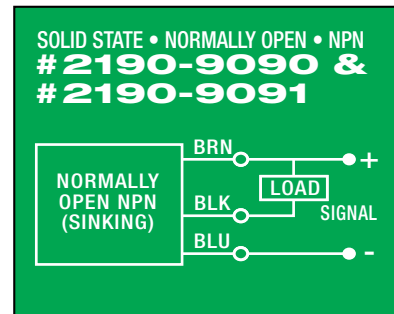
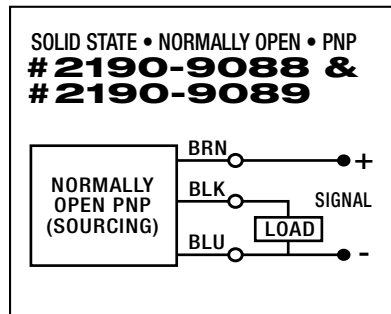
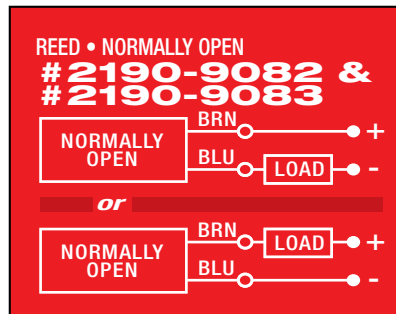

## SWITCH DIMENSIONS

☐ Y - direct connect

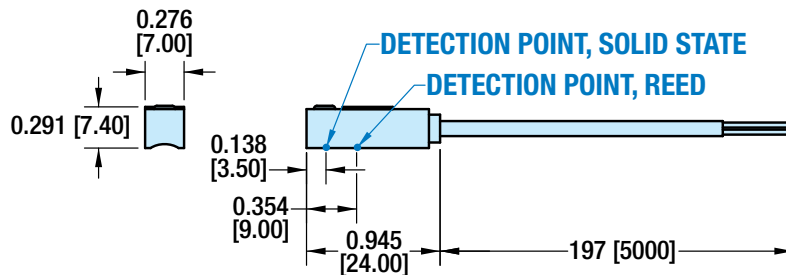

☐ K - QD (Quick-disconnect) switch

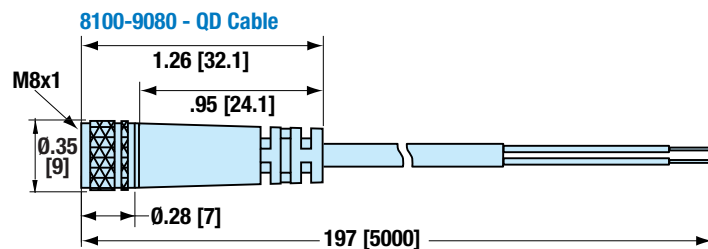

## SWITCH CLAMP

#2190-1079 SIZES 06, 10, 15, 20, 22  
#2503-1044 SIZES 25, 22, 30

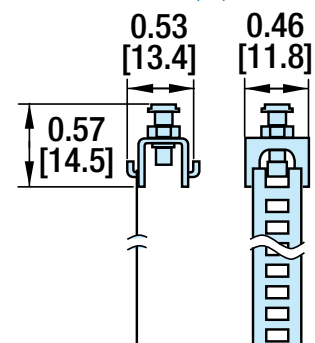

# APPLICATION DATA WORKSHEET

Fill in known data. Not all information is required for all applications

## ORIENTATION

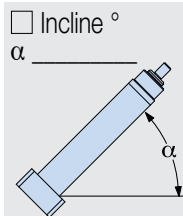
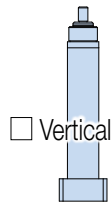
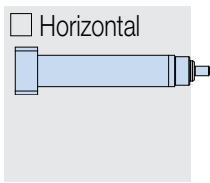

Load supported by actuator OR  Load supported by other mechanism

## MOVE PROFILE

### EXTEND

Move Distance \_\_\_\_\_

inch (US conventional)  millimeters (Metric)

Move Time \_\_\_\_\_ sec

Max. Speed \_\_\_\_\_

in/sec  mm/sec

Dwell Time After Move \_\_\_\_\_ sec

### RETRACT

Move Distance \_\_\_\_\_

inch  millimeters

Move Time \_\_\_\_\_ sec

Max. Speed \_\_\_\_\_

in/sec  mm/sec

Dwell Time After Move \_\_\_\_\_ sec

## NO. OF CYCLES

per minute  per hour

## HOLD POSITION?

Required

Not Required

After Move

During Power Loss

NOTE: If load or force changes during cycle use the highest numbers for calculations

### EXTEND

#### LOAD

lb. (U.S. Standard)  kg. (Metric)

#### FORCE

lb. (U.S. Standard)  kg. (Metric)

### RETRACT

#### LOAD

lb. (U.S. Standard)  kg. (Metric)

#### FORCE

lb. (U.S. Standard)  kg. (Metric)

## STROKE LENGTH

inch (US conventional)

millimeters (Metric)

## PRECISION

Repeatability \_\_\_\_\_

inch

millimeters

## OPERATING ENVIRONMENT

Temperature, Contamination, Water, etc.

**ACTUATOR** **FREE - Windows® compatible software, at**  
**www.tolomatic.com**

**SIZING**  
 Or Call 1-800-328-2174 for  
 Excellent Customer Service & Technical Support

## MOTION PROFILE

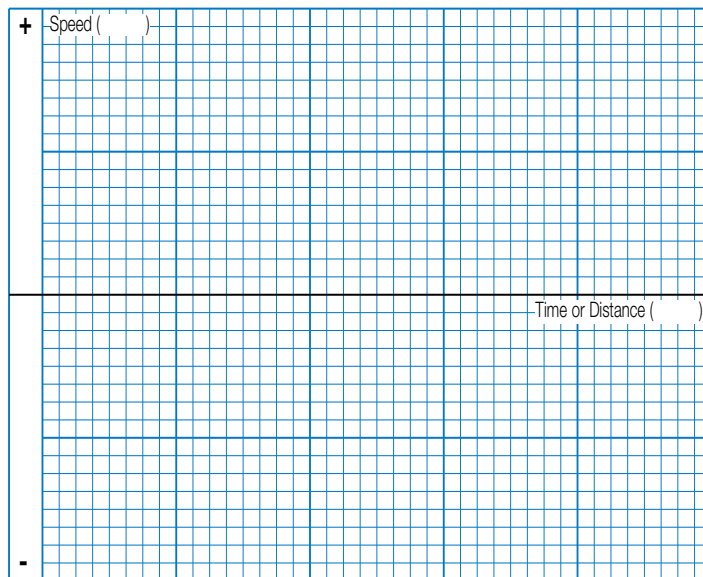

Graph your most demanding cycle, including accel/decel, velocity and dwell times. You may also want to indicate load variations and I/O changes during the cycle. Label axes with proper scale and units.

## CONTACT INFORMATION

Name, Phone, Email  
 Co. Name, Etc.



**USE THE TOLOMATIC SIZING AND SELECTION SOFTWARE AVAILABLE ON-LINE AT [www.tolomatic.com](http://www.tolomatic.com) OR... CALL TOLOMATIC AT 1-800-328-2174.** We will provide any assistance needed to determine the proper actuator for the job.

FAX 1-763-478-8080

EMAIL [help@tolomatic.com](mailto:help@tolomatic.com)

# ERD – Electric Rod-Style Actuator



## Selection Guidelines

### 1 ESTABLISH MOTION PROFILE

Using the application stroke length, desired cycle time, loads and forces, establish the motion profile details including linear velocity and thrust in each of its segments.

### 2 SELECT ACTUATOR SIZE AND SCREW TYPE

Based on the required velocities and thrust select a size and screw type and lead of the ERD actuator.

### 3 VERIFY CRITICAL SPEED OF THE SCREW

Verify that the application's peak linear velocity does not exceed the critical speed value for the size and lead of the screw selected.

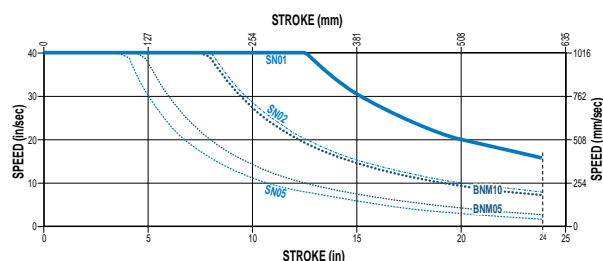

### 4 VERIFY AXIAL BUCKLING STRENGTH OF THE SCREW

Verify that the peak thrust does not exceed the critical buckling force for the size of the screw selected.

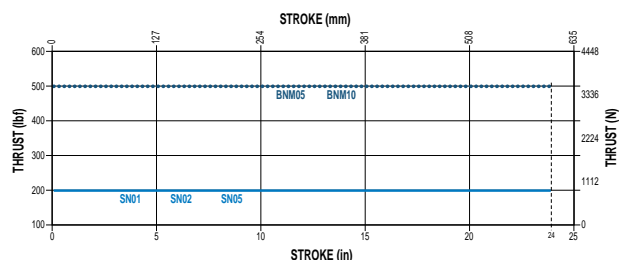

### 5 ESTABLISH TOTAL TORQUE REQUIREMENTS

Calculate total system inertia. The peak and RMS torque required from the motor to overcome internal friction, external forces and accelerate/decelerate the load.

### 6 VERIFY PV VALUE (IF ACME)

Verify that the PV value does not exceed the PV value for the size of the screw selected.

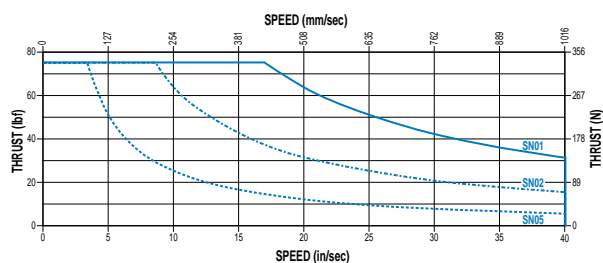

### 7 CALCULATE LIFE (IF BALL SCREW)

Determine the practical load of the system to calculate the L10 estimated life.

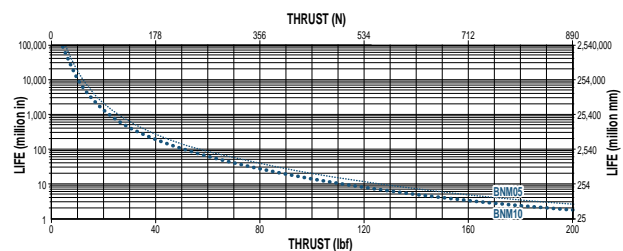

### 8 DETERMINE IF LOAD GUIDANCE IS NEEDED

If application requires carrying a load, anti-rotate, a tooling plate or there is risk of side loading the rod, choose the guided option. **(G|D|2)** Available sizes: 06, 10, 15, 20

### 9 DETERMINE IF INGRESS PROTECTION AGAINST DUST AND WATER IS NEEDED.

If actuator is in contact with dust particulate, water or washdown environment choose the IP67 or IP69k option.

**(I|P|6|7)** Available sizes: 06, 10, 15, 20;

**(I|P|6|9|k)** Available sizes: [15 & 20 with SS2], 22, 25, 30

### 10 DETERMINE IF ENVIRONMENT IS CORROSIVE OR WASH DOWN

If corrosion resistance is required for 06-20 sizes, choose from two options of stainless steel components

- **(S|S|1)** ERD with all stainless steel components
- **(S|S|2)** ERD with all stainless steel components and protective motor enclosure.

For 22, 25 & 30 sizes choose **(I|P|6|9|k)**

### 11 SELECT MOUNTING AND SENSOR CHOICES

Mounting options include: **(T|R|N)** trunnion mount, **(F|F|G)** front flange mount, **(F|M|2)** foot mount. 6 sensor choices include: reed, solid state PNP or NPN, all in normally open, with flying leads or quick-disconnect couplers.

### 12 SELECT ACTUATOR CONTROL SOLUTION

Add an extremely easy to use drive and motor combination to power the actuator.

# ERD – Electric Rod-Style Actuator



## SERVICE PARTS ORDERING

### ERD ACTUATOR REPLACEMENT KITS

Code	Description	ERD SIZE			
		06	10	15	20
FFG	Front Flange Mount Kit	2190-1025	2191-1025	2192-1025	2193-1025
FM2	Foot Mount Kit	2190-9001	2191-9001	* 2192-9001	2193-9001
TRR	**Trunnion Mount	1820-1003 (order 2)	0610-1044 (order 2)	6000-1785 (order 2)	2193-1018 (order 2)
IP67	***IP67 Kit	2190-9201	2191-9201	2192-9201	2193-9201
IP69K	***IP69K Kit	–	–	2192-9221	2193-9202
GD2	Guide Kit	Order via configurator code: GD2ERD__SM__._._			

\* REPLACEMENT ONLY: If ERD15 unit was built with SS2 option, foot mount kit 2192-9203 is required.

\*\* REPLACEMENT ONLY: Trunnion mount option not available with SS2 option

\*\*\* REPLACEMENT ONLY: If used on an actuator that was not originally built with the IP67 option the thrust rod will retract below the Cap/Seal and may damage the seal

Code	Description	ERD SIZE		
		22	25	30
FFG	Front Flange Mount Kit	2195-9052	2194-9052	2194-9052
FM2	**Foot Mount Kit	2195-9053	2194-9053	2194-9053
TRR	**Trunnion Mount	2195-1071 (order 2)	1150-1411 (order 2)	1150-1411 (order 2)

\*\* REPLACEMENT ONLY

NOTE: IP69K replacement kit not available for ERD22, ERD+25 & ERD30 - return to Tolomatic for service

### ERD SWITCHES

To order switch kits use configuration code for switch preceded by SW and actuator code.

EXAMPLE: **SWERD15KK**



The example is for 3 Solid State NPN, Normally Open Switches with Quick-disconnect couplers. Each switch is complete with Bracket, Set Screw, Switch and mating QD cable.

To order switch ONLY see part number in table

Code	†Switch ONLY Part No.	Lead	Normally	Sensor Type
<b>R</b> <b>Y</b>	2190-9082	5m (197 in)	Open	Reed
<b>R</b> <b>K</b>	2190-9083††	Quick-disconnect		
<b>T</b> <b>Y</b>	2190-9088	5m (197 in)	Open	Solid State PNP
<b>T</b> <b>K</b>	2190-9089††	Quick-disconnect		
<b>K</b> <b>Y</b>	2190-9090	5m (197 in)	Open	Solid State NPN
<b>K</b> <b>K</b>	2190-9091††	Quick-disconnect		

†Also order clamp assembly #2190-1079 sizes 06, 10, 15, 20, 22  
#2503-1044 sizes 25, 30

††Also order mating QD cable #8100-9080

# ERD – Electric Rod-Style Actuator



## ERD ORDERING

BASE MODEL

ERD 15 SN02 SM152-4 LMI

## OPTION ORDERING

ARI SS1 IP67 FFG KK2

MODEL	
ERD	Rod-Style Actuator

SIZE			
06	10	15	20
22	25	30	

NUT/SCREW COMBINATIONS		
SIZE	CODE	TURNS/in (TPI)
06	SN	02, 04, 16
10	SN	01, 02, 05
	BNM	05 mm lead
15	SN	01, 02, 05
	BNM	05, 10 mm lead
20	BNM	05, 10, 20 mm lead
22	BN	02, 05
	BNM	05, 10, 20 mm lead
	RN	05, 10 mm lead
25	BN	01, 02, 04
	BNM	05, 10, 25 mm lead
	RN	05, 10 mm lead
30	BN	04
	BNM	05, 10, 20mm lead

STROKE LENGTH		
SM_ _	Enter desired stroke length in millimeters (25.4mm = 1 inch)	
MAXIMUM STROKE		
SIZE	ERD	
	mm	in
06	203.2	8
10	254.0	10
15,20	609.6	24
22,25,30	1000.0	39.4

Contact Tolomatic with requests for longer strokes

MOTOR MOUNTING	
LMI	In-line motor mount
RP1*	1:1 ratio, Reverse Parallel motor mount
RP2*	2:1 ratio, Reverse Parallel motor mount
22, 25 & 30 size RP TORQUE CHOICES	
ST	Less than 60 in/lbs torque to actuator
HT	More than 60 in/lbs torque to actuator

ACTUATOR GUIDE & ANTI-ROTATE	
GD2	Guided unit with 2 guide shafts & tooling plate
ARI	Internal Anti-Rotate for 15, 22, 20, 25, 30 sizes only (ARI not available for 22 BN)

- GD2 is always aluminum even when ordered with SS1
- GD2 is not available for 22, 25, 30 size

ENVIRONMENTAL PROTECTION	
SS1	Stainless steel actuator
SS2_*	Stainless steel actuator with protective motor enclosure
SS21	NPT 1/2" conduit thread
SS22	M20x1.5 conduit thread
SS23	Cord grip(s), 1 or 2 grips determined by encoder choice
IP67	See chart below
IP69K	See chart below (IP ratings defined on pg. ERD_11)
HYG1	(ERD22, 25 & 30 only) IP69k Ingress protection rating (static), dust protection, high pressure water spray

- \*\*NOTE: Only Tolomatic motors are available with the SS2 option
- \*SS2 is not available for 06, 22, 25, 30 size

NOTE: ERD15 & ERD20: IP69K available only together with SS2 option

ACTUATOR MOUNTING	
FFG**	Front Flange Mount
TRR†	Trunnion Mounting, Rear
FM2**	Foot Mount
PCD	Rear Clevis Mounting, for RP 15, 20, 22, 25, 30 sizes only

SWITCHES**							
TYPE	LOGIC	NORMALLY	QUICK-DISCONNECT	CODE	QUANTITY		
REED	SPST	Open	No	RY	After code enter quantity desired		
			Yes	RK			
SOLID STATE	PNP	Open	No	TY			
			Yes	TK			
			NPN	Open		No	KY
						Yes	KK
						5 m (16.4 feet)	
						6 in (152mm) to QD connector w/ 5m lead	

- \*\*NOTE: Foot Mount, Front Flange Mount and Switches are shipped together with the actuator but are not installed by Tolomatic.

Not all codes listed are compatible with all options. Contact Tolomatic with any questions.



### CUSTOM MOTOR MOUNTS. 15 DAYS.

Select a high-performance Tolomatic electric actuator and we'll provide a motor-specific interface for YOUR motor. With our online database, you can select from over 60 motor manufacturers and hundreds of models. Visit [www.tolomatic.com/yhm](http://www.tolomatic.com/yhm) today to find your motor/actuator match!

### ADD ANY MOTION SYSTEM TO OUR ACTUATOR OR

### SELECT A COMPLETE SYSTEM FROM TOLOMATIC



- Motors •Drives •Controllers •Gearboxes

Tolomatic offers digital servo or stepper drives with motors matched to provide optimal performance with Tolomatic actuators.

CONFIGURE AN ACTUATOR AND A COMPLETE MOTION CONTROL SYSTEM TODAY USING TOLOMATIC'S EASY-TO-USE ON-LINE SIZING & SELECTION



IP RATING CHOICES AVAILABLE			USDA Approved Available	MOTOR ENCLOSURE AVAILABLE
Size	IP40	IP67		
06	Std.	YES	-	-
10	Std.	YES	-	YES
15	Std.	YES	YES	YES
20	Std.	YES	YES	YES
22	-	-	Std.	YES
25	-	-	Std.	YES
30	-	-	Std.	YES

\*RP is not available for the 06 & 10 size

# THE TOLOMATIC DIFFERENCE

What you expect from the industry leader:



## EXCELLENT CUSTOMER SERVICE & TECHNICAL SUPPORT

Our people make the difference! Expect prompt, courteous replies to all of your application and product questions.



## INDUSTRY LEADING DELIVERIES

Tolomatic continues to offer the fastest delivery of standard catalog products. Modified and custom products ship weeks ahead of the competition.

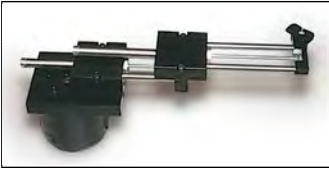

## INNOVATIVE PRODUCTS

From standard catalog products... to modified products... to completely unique custom products, Tolomatic designs and builds the best solutions for your challenging applications.



## ONLINE SIZING & SELECTION SOFTWARE

Online sizing that is easy to use, accurate and always up-to-date. Input your application data and the software will determine a Tolomatic electric actuator to meet your requirements.



## 3D MODELS & 2D DRAWINGS AVAILABLE ON THE WEB

Easy to access CAD files are available in many popular formats.

## ALSO CONSIDER THESE OTHER TOLOMATIC PRODUCTS:

### PNEUMATIC PRODUCTS



*RODLESS CYLINDERS: Band Cylinders, Cable Cylinders, MAGNETICALLY COUPLED CYLINDERS/SLIDES; GUIDED ROD CYLINDER SLIDES*

"FOLDOUT" BROCHURE #9900-9075  
PRODUCTS BROCHURE #9900-4028

### ELECTRIC PRODUCTS



*ROD & GUIDED ROD STYLE ACTUATORS, HIGH THRUST ACTUATORS, SCREW & BELT DRIVE RODLESS ACTUATORS, MOTORS, DRIVES AND CONTROLLERS*

"FOLDOUT" BROCHURE #9900-9074  
PRODUCTS BROCHURE #9900-4016

### POWER TRANSMISSION PRODUCTS



*GEARBOXES: Float-A-Shaft®, Slide-Rite®; DISC CONE CLUTCH; CALIPER DISC BRAKES*

"FOLDOUT" BROCHURE #9900-9076  
PRODUCTS BROCHURE #9900-4029



3800 County Road 116 • Hamel, MN 55340 U.S.A.  
Phone: (763) 478-8000 • Fax: (763) 478-8080

Toll-Free: **1-800-328-2174**

Email: [help@tolomatic.com](mailto:help@tolomatic.com) • <http://www.tolomatic.com>

All brand and product names are trademarks or registered trademarks of their respective owners. Information in this document is believed accurate at time of printing. However, Tolomatic assumes no responsibility for its use or for any errors that may appear in this document. Tolomatic reserves the right to change the design or operation of the equipment described herein and any associated motion products without notice. Information in this document is subject to change without notice.

Visit [www.tolomatic.com](http://www.tolomatic.com) for the most up-to-date technical information

