

H441 Caliper Disc Brake

Models Included:
 H441D 0774-0000
 H441DG 0774-0001

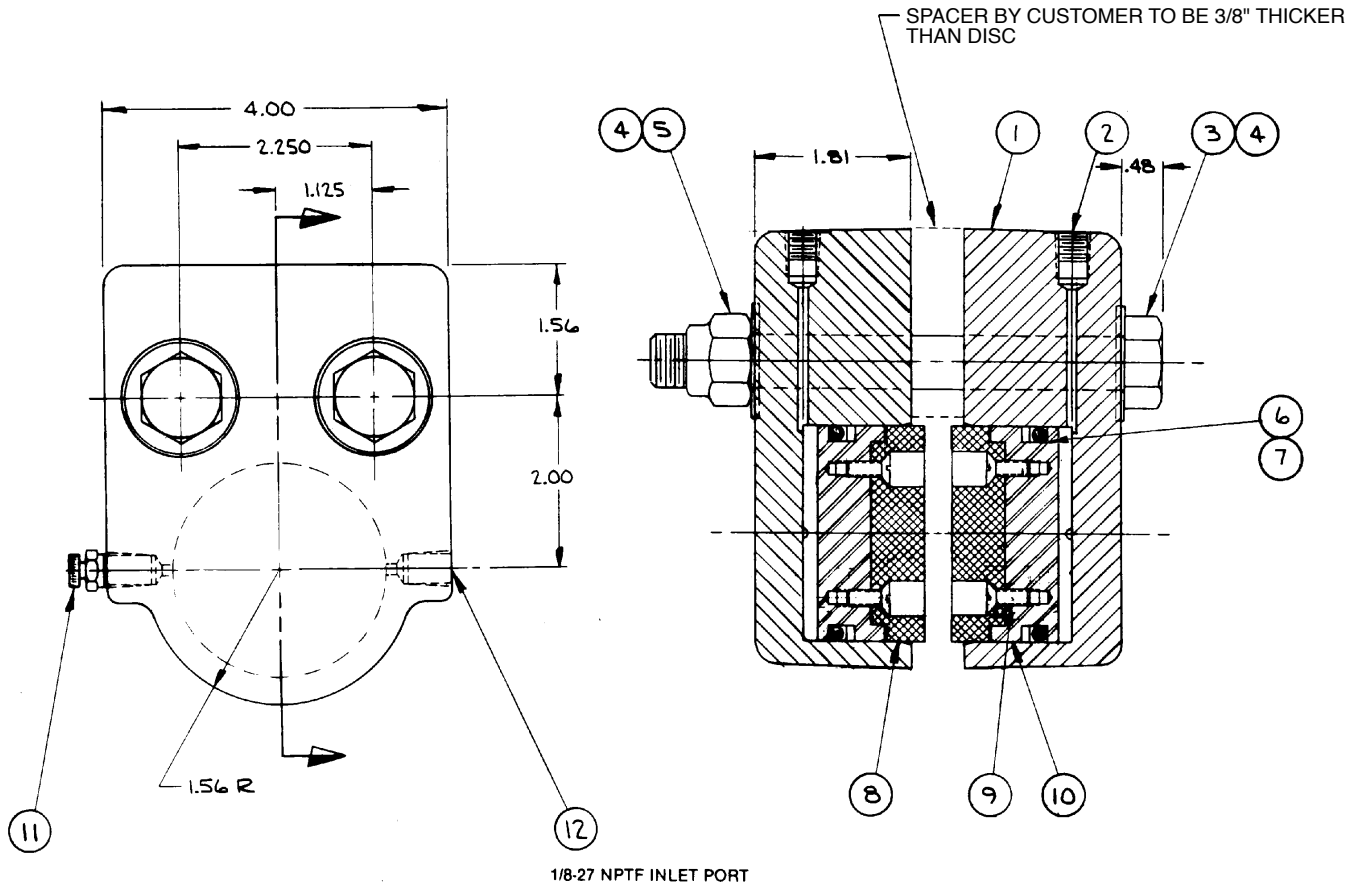

1/8-27 NPTF INLET PORT

Parts List

Item	Part No.	Description	Quantity	
			H441D	H441DG
1.	0774-1001	Housing	2	2
2.	1014-1065	Pipe Plug	2	2
3.	3035-1008	Bolt, HHC 5/8-18 x 5.50	2	2
4.	0774-1003	Washer, Flat	4	4
5.	0778-1020	Hex Lock Nut	2	2
6.	0774-1007	O-Ring, Buna-N	2	
	0774-1008	O-Ring, EPR		2

Item	Part No.	Description	Quantity	
			H441D	H441DG
7.	0774-1009	Back-up Ring, Buna-N	2	
	0774-1015	Back-up Ring, Teflon		2
8.	0774-1006	Puck	2	2
9.	0720-1009	Screw, Flat Head	4	4
10.	0774-1005	Piston	2	2
11.	0740-1002	Valve, Bleeder	2	2
12.	1001-1066	Plug, Vinyl	2	2

Bolts (3) supplied are for disc thicknesses up to 1/2". Longer bolts are available for discs with thicknesses over 1/2". Please specify disc thickness when ordering.

NOTE: Model number letter suffixes have the following meanings:

"D" indicates the brake is double acting.

"G" indicates the brake uses EPR seals.

MAXIMUM PRESSURE RATING: 1,500 PSI (103.4 BAR).

INSTALLATION

1. The H441 Caliper is to be fixed mounted and used with a fixed disc. Mount the Caliper as shown at right.
2. Torque the 5/8-18 HHCS mounting Bolts (#3) to 50 ft-lbs (67.8 N-m)
3. Care must be taken in mounting the Caliper. Puck faces must be parallel to the disc.
4. In replacing Pucks (#8), Screws (#9) must be inserted with Loctite® and torqued to 20 in-lbs (2.26 N-m).
5. The H441 Caliper may be operated hydraulically up to 1500 PSI (103.4 bar). Be sure fluid being used is compatible with seals. If there is a suffix "G", then automotive brake fluid must be used.
6. Pressure in the brake must be relieved when the brake is off. Do not operate Caliper with master cylinders that have a residual pressure check valve. This back pressure will cause drag and excess heat which will result in reduced puck life.
7. The H441 is provided with two Bleeder Valves (#11). Mount the Caliper so the Bleeders are at the highest elevation possible. Improper bleeding will cause poor braking performance.
8. Each brake half will have to be plumbed separately.

Loctite® is a registered trademark of the Loctite Corporation, www.loctite.com.

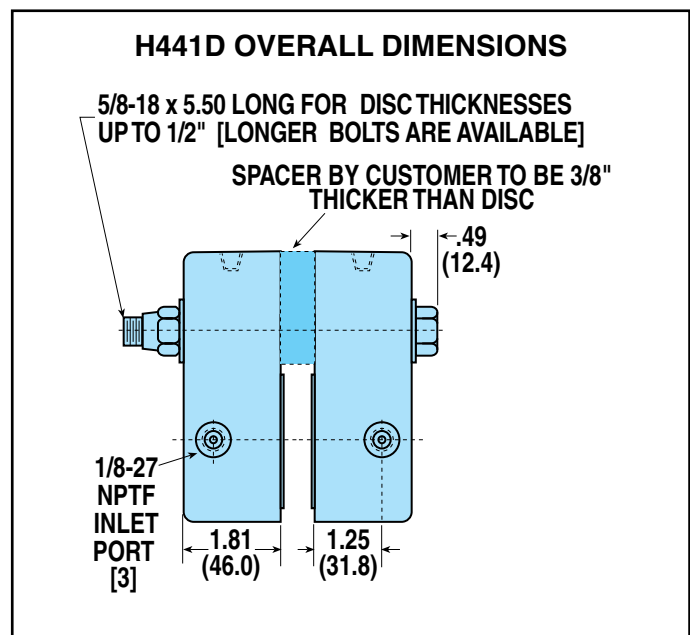
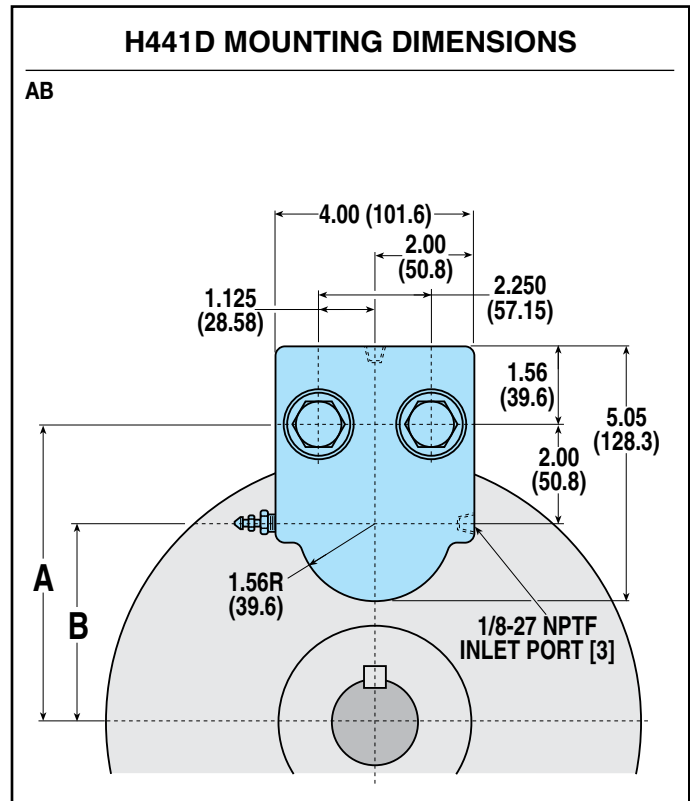

NOTE: Model number letter suffixes have the following meanings:

"D" indicates the brake is double acting.

"G" indicates the brake uses EPR seals.

MAXIMUM PRESSURE RATING: 1,500 PSI (103.4 BAR).



3800 County Road 116, Hamel, MN 55340
 http://www.Tolomatic.com • Email: Help@Tolomatic.com
 Phone: (763) 478-8000 • Fax: (763) 478-8080 • Toll Free: 1-800-328-2174



Information furnished is believed to be accurate and reliable. However, Tolomatic assumes no responsibility for its use or for any errors that may appear in this document. Tolomatic reserves the right to change the design or operation of the equipment described herein and any associated motion products without notice. Information in this document is subject to change without notice.