

MANUAL

FOR INSTALLATION, MAINTENANCE AND OPERATION

ServoWeld[™] Actuators CSWL Models

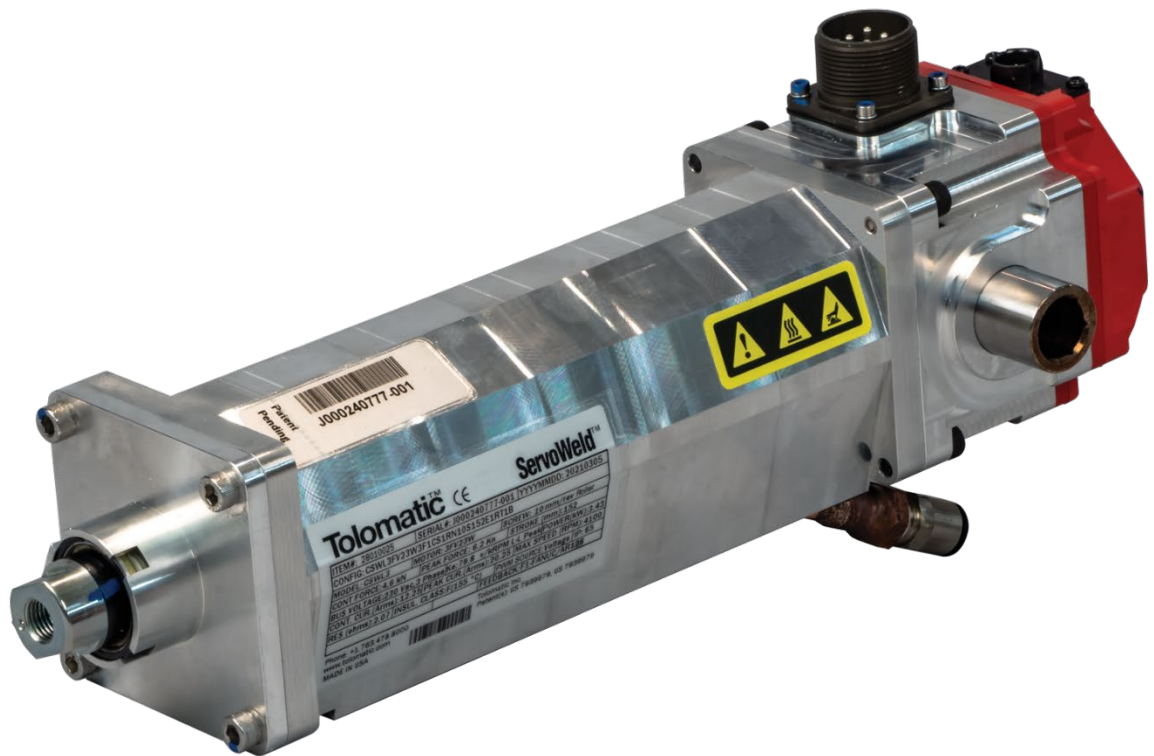

Tolomatic reserves the right to change the design or operation of the equipment described herein and any associated motion products without notice. Information in this document is subject to change without notice.

Copyright © 2022 Tolomatic, Inc. All rights Reserved.

All brand and product names are trademarks of their respective owners. Information in this document is believed to be accurate at time of publication.

Original Instructions - English

Translations will be supplied in other community languages as required by customers

■ Table of Contents

●	TABLE OF CONTENTS	3
●	LIST OF TABLES AND FIGURES:	6
●	1.0 SAFETY	7
●	1.1 SAFETY SYMBOLS	7
●	GENERAL	7
●	SAFETY SYMBOLS	7
	WARNING FOR HOT SURFACES	7
●	1.2 SAFETY CONSIDERATIONS	8
●	PROPER AND SAFE USE OF PRODUCT	8
●	FAIL SAFE E-STOP RECOMMENDATIONS	8
●	DEVICE DAMAGE PREVENTION	8
●	PERSONAL SAFETY	8
●	HANDLING AND UNPACKING	8
●	PACKING AND TRANSPORT	8
●	MODIFICATIONS TO THE EQUIPMENT	9
●	REPAIR AND MAINTENANCE	9
●	REQUIREMENT REGARDING PERSONNEL	9
●	RISK AREA AND PERSONNEL	9
●	2.0 CSWL SERVOWELD™ PRODUCT OVERVIEW:	10
●	2.1 GENERAL DESCRIPTION	10
●	2.2 INTENDED USE	10
●	2.3 STORAGE	11
●	2.4 IDENTIFICATION LABEL	11
●	2.5 CERTIFICATION	11
●	2.6 MANUFACTURER	11
●	3.0 SERVOWELD™ CONFIGURATION OVERVIEW	12
●	3.1 SERIES CONFIGURATION	12
●	3.2 STANDARD CONFIGURATIONS AND OPTIONS	12
●	3.2.1 ANTI-ROTATION	13
●	3.2.2 SCREW SELECTION	13
●	3.2.3 MOTOR VOLTAGE	13
●	3.2.4 WATER COOLING OPTION	13
●	3.2.5 MOUNTING OPTIONS	13
●	3.2.6 ROD END	13
●	3.2.7 INTERNAL HOLDING BRAKE OPTION	13
●	3.2.8 FEEDBACK DEVICE	13
●	3.2.9 CONNECTOR(S)	13
●	3.2.10 SERVO DRIVE	13
●	4.0 CSWL SERVOWELD™ MECHANICAL INSTALLATION	14
●	4.1 SERVOWELD™ ACTUATOR SYSTEM CONFIGURATION	14

- **4.2 ACTUATOR OPERATION 14**
 - GENERAL OPERATION 14
 - COLD TEMPERATURE STARTUP PROCEDURE 15
 - TIP DRESS PROCEDURE..... 15
- **4.3 PLANNING YOUR INSTALLATION 16**
 - INSTALLING THE SERVOWELD™ WELD ACTUATOR..... 16
 - SIDE LOAD CONSIDERATIONS..... 16
 - THRUST ROD WIPER/SCRAPER 17
 - CABLES 17
 - RSW SERVO SYSTEM CALIBRATION 17
 - WELD TIP / PART CONTACT SPEED 17
 - ROBOT CARRIED APPLICATIONS..... 17
 - TOOL CHANGER APPLICATIONS 17
 - FIXED/PEDESTAL APPLICATIONS..... 17
- **4.4 MOUNTING 18**
 - THRUST ROD ATTACHMENT - ROUND THRUST ROD 18
 - THRUST ROD CONNECTION: 18
 - TRUNNION MOUNT 18
- **4.5 WATER COOLING OPTION 19**
- **5.0 CSWL SERVOWELD™ ELECTRICAL INSTALLATION 20**
- **5.1 EMC WIRING GUIDELINES 20**
 - CABLE ROUTING 20
 - SHIELDING AND GROUNDING 20
- **5.2 CONNECTOR ORIENTATION 20**
- **5.3 FEEDBACK INFORMATION 21**
 - 5.3.1 FEEDBACK COMMUTATION..... 21
 - 5.3.2 FEEDBACK COMMUTATION DETAILS 22
 - ABSOLUTE ENCODER FEEDBACK 22
 - RESOLVER FEEDBACK 22
 - SERVOMOTOR INFORMATION: 23
- **5.4 CONNECTOR PINOUTS 24**
 - FEEDBACK CODE: A1 – ABB 24
 - FEEDBACK CODE: F1 - FANUC/AIAR128..... 25
 - FEEDBACK CODE: K1 - KUKA..... 26
 - FEEDBACK CODE: M1 - MOTOMAN YASKAWA..... 27
 - FEEDBACK CODE: N1 - NACHI; FD11..... 28
 - FEEDBACK CODE: P1 – PARKER LTN..... 29
- **6.0 CSWL OPERATION AND START UP CONSIDERATIONS..... 30**
- **6.1 ATTACHING CABLES & HOMING / MECHANICAL TRAVEL LIMITS..... 30**
- **6.2 BRAKE 30**
 - SERVOWELD™ BRAKE SPECIFICATIONS..... 31

- **7.0 MAINTENANCE & REPAIR..... 32**
- **7.1 LUBRICATION..... 32**
- **7.2 PERIODIC MAINTENANCE..... 32**
 - PROCEDURE FOR LUBRICATION..... 33
- **7.3 SERVOWELD™ REFURBISHMENT & REMANUFACTURING SERVICE..... 33**
- **APPENDIX A: ACTUATOR SPECIFICATIONS 34**
- **MOTOR SPECIFICATIONS: 35**
 - STANDARD THERMAL SWITCH SPECIFICATIONS..... 35
- **APPENDIX B: TROUBLESHOOTING PROCEDURE 36**
- **APPENDIX C: WARRANTY 38**
- **C.1 WARRANTY..... 38**
 - WARRANTY AND LIMITATION OF LIABILITY 38
 - LIMITED WARRANTY 38
 - LIMITATION OF LIABILITY..... 39
 - PRODUCT RETURN PROCEDURE 39
- **APPENDIX D: DECLARATION OF CONFORMITY..... 40**

List of Tables and Figures:

FIGURE 2.1: EXAMPLE OF SERVOwELD ACTUATOR INSTALLED ON “X” STYLE WELD GUN UNIT. 10

FIGURE 2.2: SERVOwELD ACTUATOR IDENTIFICATION LABEL. 11

FIGURE 3.1: CSWL ORDERING CODES AND DESCRIPTIONS 12

FIGURE 4.1: TYPICAL CONNECTIONS FOR A SINGLE-AXIS SYSTEM WITH A SERVOwELD™ ACTUATOR WITH OPTIONAL BRAKE TO A RSW SERVO SYSTEM DRIVE 14

FIGURE 4.2: SIDE LOAD MUST NOT EXCEED MAXIMUM VALUES REPRESENTED BY THE LINES IN THE GRAPH 16

FIGURE 4.3: FOR ROUND ROD, HOLD THRUST ROD STATIONARY USING A WRENCH ON THE FLATS AT THE END OF THE ROD WHEN ATTACHING ACCESSORIES, LINKAGES OR LOAD TO THE ACTUATOR. USE A TORQUE WRENCH TO TIGHTEN THE INTERFACING ROD END TO THE ACTUATOR THREADED CONNECTION POINT. TORQUE VALUES PROVIDED IN TABLE 2.2 18

TABLE 4.1: ROD END TORQUE RECOMMENDATIONS 18

FIGURE 4.5: VIEW OF WATER COOLING OPTION 19

FIGURE 5.1: RECOMMENDED ROUTING OF SERVOwELD CABLING. 20

FIGURE 5.2: CONNECTOR ROTATION. NOTE THAT THE TOLOMATIC STANDARD CONNECTORS MAY BE ROTATED FROM -90° TO +180° ALLOWING FOR CABLES TO CONNECT TOWARD THE FRONT (ROD END, AS MANUFACTURED), TO EITHER SIDE, BOTH SIDES, OR BACK OF ACTUATOR..... 21

FIGURE 5.3: DRAWING OF BOX MOUNT CONNECTORS USED ON SOME SERVOwELD ACTUATORS..... 21

FIGURE 5.4: THRUST ROD MOVEMENT RELATIVE TO MOTOR ROTATION. 22

FIGURE 5.5: MOTOR ROTATIONAL POSITION AT 0 23

FIGURE 5.6: MOTOR ROTATIONAL POSITION AT 90 23

TABLE 5.1: ABSOLUTE ENCODER AND RESOLVER FEEDBACK DATA 23

TABLE 6.1: SERVOwELD BRAKE SPECIFICATIONS..... 31

FIGURE 6.2: FASTEST ENGAGE / DISENGAGE TIME, LEAST PROTECTION 31

TABLE 7.1: PERIODIC MAINTENANCE SCHEDULE. 32

FIGURE 7.1: A FLUSH GREASE ZERK ALLOWS PERIODIC RELUBRICATION FOR SERVOwELD ACTUATORS. THIS CAN TYPICALLY BE PERFORMED IN 5 MINUTES WITHOUT REMOVING THE ACTUATOR FROM ITS INSTALLATION. 32

1.0 Safety

1.1 Safety Symbols

General

Read completely through the applicable sections of the manual before the equipment/unit is unpacked, installed or operated. Pay careful attention to all of the dangers, warnings, cautions and notes stated in the manual.

Serious injury to persons or damage to the equipment may result if the information in the manual is not followed.

Safety Symbols

Items that are specifically marked DANGER, WARNING, CAUTION, PROHIBITIVE, MANDATORY ACTION, or NOTE! are arranged in a hierarchical system and have the following meaning:



Indicates a very hazardous situation which, if not avoided, could result in death or serious injury. This signal word is limited to the most extreme situations.



Indicates a potentially hazardous situation which, if not avoided, could result in death or serious injury.



Indicates a potentially hazardous situation which, if not avoided, may result in property damage, minor or moderate injury.



Indicates Prohibited Action



Indicates Mandatory Action



Information that requires special attention is stated here.



WARNING FOR HOT SURFACES

WARNING! Normal operating temperature of weld actuator can range from 135 degrees F (57°C) to 175 degrees F (79°C).

■ 1.2 Safety Considerations

■ Proper and Safe Use of Product

■ Fail Safe e-Stop Recommendations

When motor is attached, a means for a fail safe e-stop is highly recommended to ensure equipment and personal safety. The e-stop should provide a means to remove main power from the actuator to cease and prevent any unwanted motion.

■ Device Damage Prevention

To prevent permanent damage to the device, proper care should be taken not to exceed published voltage, current, temperature, and load/force ratings. In addition, proper mechanical assembly and proper wiring should be verified and safety measures checked before applying power to the complete equipment package.

■ Personal Safety

During normal operation the motor can become hot, especially the motor housing. In addition, the case ground should be tied to an earth ground to prevent the presence of case voltage.

During normal operation, the actuator rod travels in and out creating a possible pinch point.

Proper guarding and signage must be used prevent entry into possible pinch zones and contact with hot surfaces. It is highly recommended to display proper safety notices and implement proper safety measures to prevent contact with hot surfaces.

■ Handling and Unpacking

When unpacking and handling the actuator, care should be taken not to drop the actuator as this can damage the connectors, internal electronics, or cause misalignment of the actuator feedback device. Damage the internal mechanical components may cause poor performance or render the actuator non-functional. Since this is an electromechanical device, proper ESD measures should be taken to avoid static electricity from contacting the signal and power lines of the device, as this can damage the internal mechanical components rendering the actuator damaged or non-functional.

■ Packing and Transport



NOTE!

Package actuator to prevent damage during transport. It is recommended that the actuator be returned in its original packaging. If the original packaging is not available, the follow these recommendations.

1. Foam in place if possible.
2. Reinforce ends of box with multiple layers of cardboard or wood to prevent the actuator from breaking through the packaging during shipment.
3. Support the connectors or cables so that enough packaging or foam is in place to prevent shipping damage.
4. It is best to ship one unit per container because individual items that are not isolated with stable packaging (foam in place) from each other often get damaged during shipment.
5. When shipping more than one unit in a single container, it is recommended to foam in place to prevent damage during shipping to both the units and the packaging.
6. Add the RMA number on the outside of the packaging. Failure to do so will delay processing.

⚠ CAUTION CAUTION!

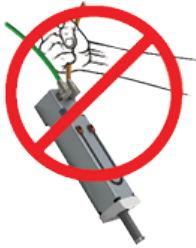

The CSWL actuator weight range is approximately 6.2 to 7.3 kg (13.5 to 15.9 lb). Special care must be taken when lifting this device. Do not carry by the connectors. The connectors are not rated to support the weight of the actuator.

■ **Modifications to the Equipment**

⚠ WARNING WARNING!

The manufacturer takes no responsibility whatsoever if the equipment is modified or if the equipment is used in any way beyond performance specifications. Unauthorized modifications or changes to the equipment are strictly forbidden and void all warranties.

■ **Repair and Maintenance**

⚠ WARNING WARNING!

All power and supply media must be shut OFF before any work is performed on any equipment that is associated with the actuator. The only field maintenance that may be performed on ServoWeld actuator include lubrication. All other repair or maintenance for ServoWeld actuator must be performed at Tolomatic or by a Tolomatic service center.

■ **Requirement Regarding Personnel**

📄 NOTE!

All personnel must be completely informed regarding all safety regulations and the function of the equipment.

■ **Risk Area and Personnel**

When installed, pinch points are generated capable of damaging forces. The risk area surrounding the ServoWeld™ actuator must either be guarded or clearly marked, including display signage in accordance with all applicable national and international legal requirements. The risk area must be protected by a safety system that stops the equipment if anyone enters the risk area. Personnel who enter the risk area must be authorized, trained and qualified for the different tasks inside the risk area.



2.0 CSWL ServoWeld™ Product Overview:

2.1 General Description

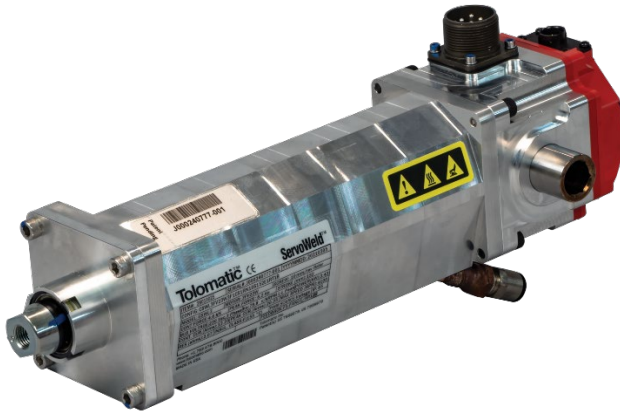

ServoWeld™ Actuators

The ServoWeld™ actuator (see figure 2.1) is a compact high-force, screw-drive servo actuator. The weld actuator provides linear motion of the moveable weld gun tip and develops the required thrust (squeeze) force for spot welding.

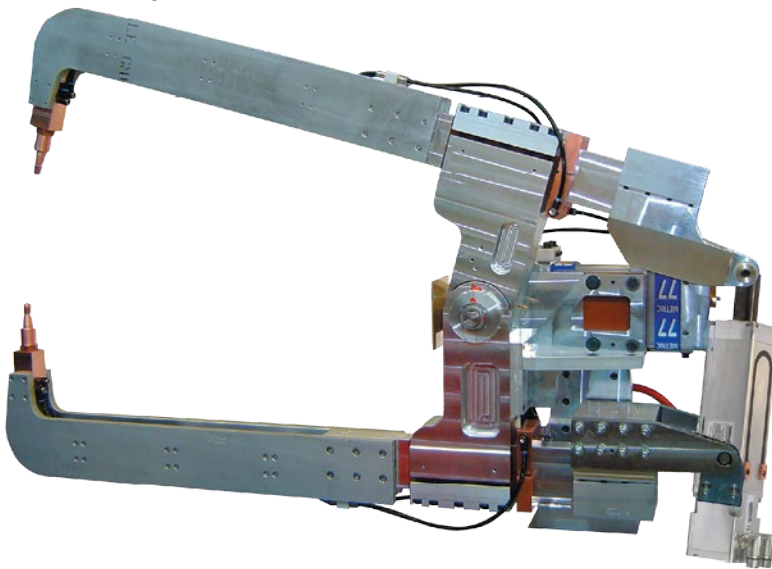

Figure 2.1: Example of ServoWeld actuator installed on “X” Style weld gun unit.

2.2 Intended Use

Commonly used in robotic and other applications the ServoWeld™ weld actuator is a compact high force roller screw drive servo actuator. The weld actuator provides linear motion of the moveable weld gun tip and develops the required thrust (squeeze) force for spot welding.

WARNING!

Before installation and commissioning of the equipment, this manual and all accompanying manufacturer documents and manuals MUST be completely read by the appropriate personnel. All warning texts must be given special attention.

2.3 Storage

Pay attention to the following when storing the actuator:

- Perform repairs, maintenance and inspections before storing equipment to ensure that the equipment is in good working order.
- Make sure the equipment is placed in a suitable storage position (horizontal) to prevent damage to the connectors and electronics.
- Protect the feedback device, which is located at the blind (non-rod end) of the ServoWeld actuator.
- Store in clean and dry environment.
- After six (6) months of storage it is recommended to cycle two complete strokes of the ServoWeld actuator to redistribute the internal lubricants.

It is also recommended to cycle the ServoWeld actuator two complete strokes before placing in service.

- If stored for a period longer than 2 years without use it may be necessary to replace the lubricants. Return to Tolomatic for this maintenance.
- Storage temperature is -25°C to +60°C (-13°F to +140°F).

2.4 Identification Label

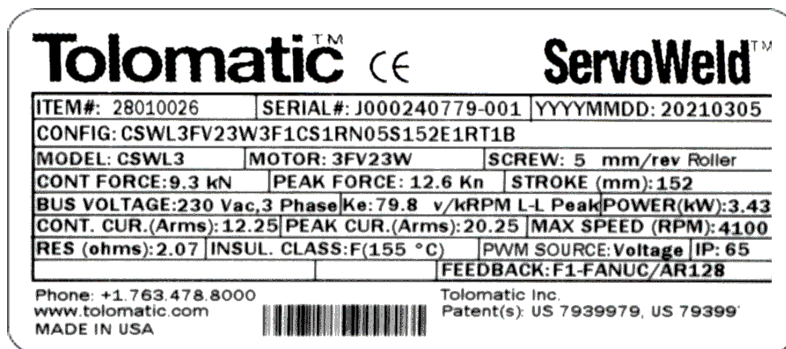

Figure 2.2: ServoWeld actuator identification label.

Do not remove the identification label. Do not render it unreadable.

2.5 Certification



2.6 Manufacturer

Tolomatic, Inc,
3800 County Road 116
Hamel, MN 55340, USA
Phone (763) 478-8000
Toll-Free 1-800-328-2174
www.tolomatic.com

3.0 ServoWeld™ Configuration Overview

3.1 Series Configuration

- Motor windings: 230 Vac & 460 Vac
- Feedback Choices:
ABB Resolver, Fanuc a128, Kuka Resolver, Motoman Absolute
Nachi Absolute FD11 Series, Parker



For performance data and specifications please refer to Appendix A.

3.2 Standard Configurations and Options



Please refer to Figure 3.1 for ordering codes. Use 3D CAD files for critical dimensions.

ServoWeld CSWL Integrated Motor Actuators

Ordering

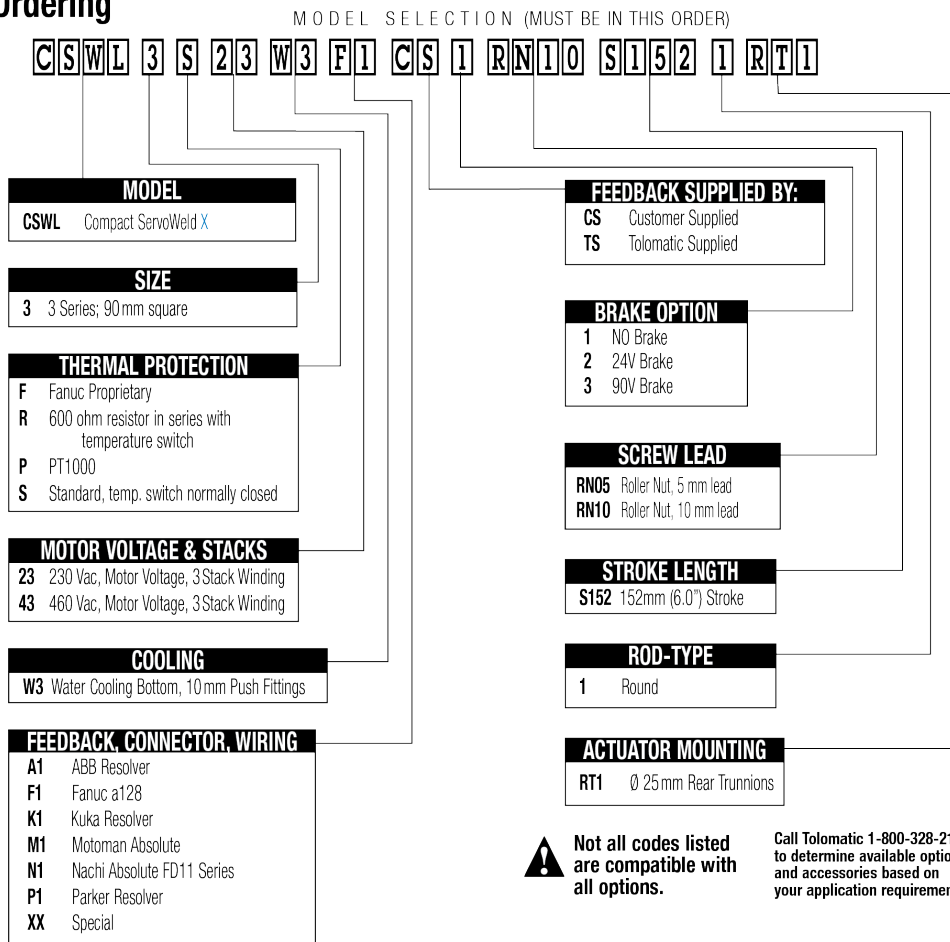

Figure 3.1: CSWL ordering codes and descriptions

■ 3.2.1 Anti-Rotation

In order to achieve linear motion with the CSWL a form of external anti rotation must be attached to the rod end.

■ 3.2.2 Screw Selection

CSWL: RN05, RN10: Roller nuts with 5mm or 10 mm lead.

RN05, RN10: Contact Tolomatic for application review and assistance in selecting a screw technology.

■ 3.2.3 Motor Voltage

CSWL: 23, 43: Available with 230 Vac or 460 Vac with 3 stack windings.

Contact Tolomatic for application review and assistance in selecting voltage and windings.

■ 3.2.4 Water Cooling Option

Available for ServoWeld actuators the integrated water cooling option is 23% more efficient compared to external designs. It allows for increased duty cycle and more welds per hour.

■ 3.2.5 Mounting Options

Trunnion mount is standard. Please consult Tolomatic for any special mounting needs

■ 3.2.6 Rod End

Metric female threaded rod end is standard. Please consult Tolomatic for any special mounting needs.

■ 3.2.7 Internal Holding Brake Option

1=No Brake, 2=24V Brake, 3=90V Brake: A spring held electronically released holding brake (parking brake) is available. The holding force of the brake is capable of holding the continuous force of the actuator. The brake is spring set and releases when voltage is applied to the brake. A separate power source is required.

■ 3.2.8 Feedback Device

Contact Tolomatic for application review and assistance in selecting feedback device.

■ 3.2.9 Connector(s)

Connectors are matched to selected feedback device. Contact Tolomatic for application review and assistance in selecting feedback device.

■ 3.2.10 Servo Drive

The ServoWeld actuators functions in the same way as a brushless servo motor. A servo drive is used to power and control the actuator. Please consult the servo drive manufacturer when sizing and selecting a servo drive for use with ServoWeld.



NOTE!

The CSWL must be ordered with all desired options. Field installation of options generally cannot be done. Call Tolomatic for complete details.

4.0 CSWL ServoWeld™ Mechanical Installation

⚠ WARNING WARNING!

Before installation and commissioning of the equipment, this manual and all accompanying manufacturer documents and manuals MUST be completely read by the appropriate personnel. All warning texts must be given special attention.

4.1 ServoWeld™ Actuator System Configuration

ServoWeld series actuators incorporate an integral brushless servo motor. The design of the motor with the proper feedback device and electrical connectors allows the actuator to be powered by the robot 7th axis of most robot manufacturers used in the automotive body shops and many commercially available servo drive/controllers. This flexibility allows the ServoWeld actuator to be used in the highest performing single and multi-axis motion control systems. It is recommended that all servo amplifiers and drives be selected based on the following important parameters:

- a) CE and UL approved system
- b) Thermal switch input
- c) Drive sizing key parameters for ServoWeld
 - i) Peak current
 - ii) Voltage
 - iii) Peak RPM
 - iv) Max current frequency

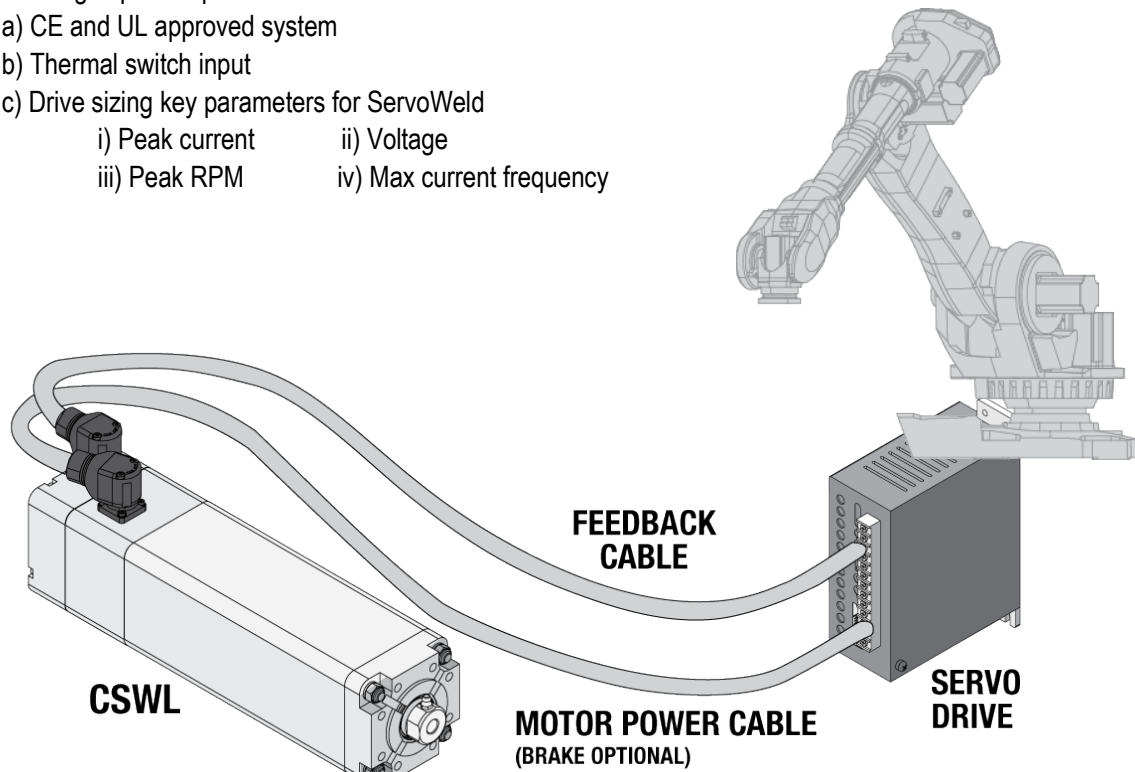

Figure 4.1: Typical connections for a single-axis system with a ServoWeld™ actuator with optional brake to a RSW servo system drive

4.2 Actuator Operation

General Operation

The ServoWeld actuator functions by converting the rotary motion of the integral brushless servo motor into linear motion using a screw mechanism. The linear travel, speeds and forces are controlled in conjunction with a RSW servo system drive.

Each ServoWeld actuator is individually configured to work with the robot controller for the specific application. The relationship between the rotary motion of the motor and the linear motion of the actuator corresponds to the following relationships:

Linear distance traveled = (motor revolutions) * (screw lead)

Linear Speed = ([motor RPM]/60) * (screw lead)

Linear Thrust (kN) = Motor torque (Nm) * 2 * π * pitch (rev/mm) * screw efficiency

or

Linear Thrust (lbf) = Motor torque (in•lb) * 2 * π * pitch (rev/in) * screw efficiency

⚠ CAUTION CAUTION!

Motor RMS current must be maintained at a level below the continuous current rating of the ServoWeld actuator or damage to the motor stator will result.

The peak current setting must be maintained at a level below the peak current rating of the ServoWeld actuator or damage to the motor stator will result.

⚠ CAUTION CAUTION!

Care should be taken to not exceed the physical travel limits of the ServoWeld actuator. Doing so will cause the actuator to reach mechanical end of stroke internally. Although protected by the end of stroke bumpers, repeatedly reaching internal end of stroke can physically damage the screw and the internal components of the actuator.

■ Cold Temperature Startup Procedure

If startup ambient temperature is between 0-10 degrees Celsius, it is recommended to cycle the ServoWeld actuator (see recommended motion profile below) to bring the temperature up to operating temperature before proceeding with welding or calibrating the system. Initiating this startup procedure will lower the friction caused by cold temperatures and result in more accurate calibration of the system and better force repeatability performance during welding. If a motion profile other than recommended below will be used for the Cold Temperature Startup Procedure, contact Tolomatic for review of the motion profile before operating the actuator.

Recommended Motion Profile:

- Extend & retract full stroke of actuator at linear speed of 150 mm/sec for 5 mm lead screws and 300 mm/sec for 10 mm lead screws
- Dwell 1 second
- Repeat 75 times

■ Tip Dress Procedure

All forces are from thrust rod output of ServoWeld actuators ONLY and does not include the complete RSW weld gun system configurations. Each weld gun and robot servo controller/drive has different operational characteristics that influence low weld force tip capability (tip dress) of the complete servo RSW weld gun system. Other factors such as temperature and the percentage of maximum output force also affect the performance and force repeatability of tip dressing. If startup ambient temperature is in 0-10 degree Celsius range, please refer to Cold Temperature Startup Procedure.

- Minimum actuator output force: 1kN (225 lbf)
- Force repeatability at tip dress force [1.0 kN (225 lbf)]: \pm 5% at steady state operating temperature

4.3 Planning Your Installation

To operate the actuator in compliance with the relevant safety regulations maximum performance limits must be observed.

⚠ CAUTION CAUTION!

When mounting your actuator in vertical or inclined positions be sure to include safety measures that control the working mass should the drive screw fail. Uncontrolled moving masses can cause injury or damage to property. If the screw drive fails, due to wear or excessive load, gravity may cause the working mass to drop.

⚠ CAUTION CAUTION!

For bench or fixture setup and testing of round rod ServoWeld actuators, the actuator thrust rod must be anti-rotated by a fixture and the actuator securely retained to the bench or fixture. Never use a hand held wrench/device to provide the anti-rotate function while the motor is powered as contact with the internal end of stroke may send the wrench/device flying and may harm the operator or damage the actuator.

■ Installing the ServoWeld™ Weld Actuator

Please refer to the weld gun documentation supplied by the weld gun manufacturer for mechanical installation.

■ Side Load Considerations

⚠ CAUTION CAUTION!

Excessive side load on the output thrust rod of the actuator will dramatically reduce the life of the actuator and should be avoided. Side load can be caused from misalignment or loading that is not inline with the actuator output thrust rod.



Some weld gun designs may subject the actuator to excessive side loading reducing overall service life. Measures are required, especially in "C" style designs, to limit side loading. For life optimization Tolomatic recommends side loads of less than 5% of axial load (thrust rod output force) for all roller screw configurations. Side loading will affect the life of the actuator.

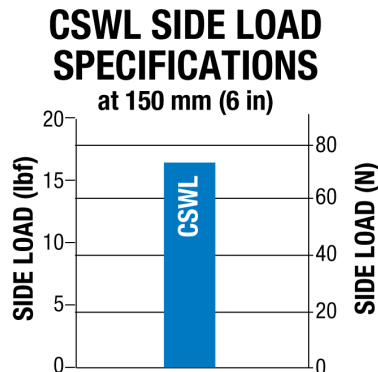

Figure 4.2: Side load must not exceed maximum values represented by the lines in the graph

The chart above shows the maximum side load values for the ServoWeld SW actuators. Measures shall be established in gun design, especially in "C" style designs, to limit any side loading that exceeds these values. For maximum service life, external guiding is recommended to minimize side loading to the thrust rod and

provide consistent weld gun movable tip/fixed tip alignment throughout service life.

■ **Thrust Rod Wiper/Scraper**

For maximum service life, measures should be taken to reduce/eliminate contamination, weld slag, and water in the thrust rod wiper/ scraper interface area. Implementation of industrial thrust rod boot and/or deflective device should be considered.

■ **Cables**

Shielded power and feedback cables are recommended to minimize electrical noise / grounding issues. Electrical noise or inadequate grounding can corrupt the feedback device signal.

CAUTION!

Power and Feedback cable lengths shall not exceed 10 meters (32.8 ft). If the application requires cable lengths longer than 10 meters please contact Tolomatic engineering for review.

■ **RSW Servo System Calibration**

For optimal RSW servo system performance, high weld force from the production weld schedule, tip dress force and multiple weld forces in between should be included in the RSW servo system Calibration process. RSW servo system consists of robot 7th axis amplifier-feedback device-software, ServoWeld™ actuator, and RSW chassis.

■ **Weld Tip / Part Contact Speed**

Tolomatic testing confirms the highest actuator repeatability (Input Current verses Output Force) at a weld tip part contact speed of 25mm/second or less. Speeds greater than 25mm/second can create “impact contribution” to the weld force. This impact contribution to the weld force deteriorates prior to completion of the weld cycle.

■ **Robot Carried Applications**

Robot carried RSW gun applications by virtue of the continuous robot movement and various RSW gun positions have reduced exposure to water pooling / water ingress. In addition, in robot carried applications, positioning of the RSW gun can be programmed as part of the weld cap change program /routine to eliminate actuator exposure to water. (ServoWeld™ actuator above weld caps)

■ **Tool Changer Applications**

Weld gun storage fixture in cell should position weld gun so movable electrode is not loading ServoWeld thrust rod - back driving the ServoWeld. Weld gun tips should be positioned to weld gun closed at low force prior to disconnect from robot/tool changer. Consider ServoWeld configured with integral brake option.

■ **Fixed/Pedestal Applications**

One of the more challenging RSW applications is a pedestal RSW gun, ServoWeld™ actuator mounted vertical – thrust rod up. Measures should be taken to reduce and/or eliminate the actuator to water exposure, water pooling/spray in the access areas of the ServoWeld unit to maximize overall service life. Because water is a factor in the RSW gun environment as a result of regular weld cap changes there are a number of steps can be taken to reduce and/or eliminate the actuator’s exposure to water.

- Pedestal RSW guns that can be mounted with the ServoWeld actuator vertical – thrust rod down should be considered.
- Pedestal RSW guns that must be mounted with the ServoWeld actuator vertical – thrust rod up should be mounted at an angle of a least 10 – 15% to minimize water pooling.
- Any RSW gun applications that are suspect for water exposure should utilize an external deflector (bib) or a thrust rod boot to keep the water away from the thrust rod wiper/scraper interface area.
- Any RSW gun application that is suspect for water exposure should consider utilizing a manual shut-off valve in the water saver circuit at the RSW gun. Shutting off the water prior to weld cap change can significantly reduce water exposure issues in the RSW gun environment.
- Pedestal RSW gun applications should have the mating electrical connectors (90 degree) on the cable

dress package facing down with the cable dress cables looped to reduce water ingress via the electrical connectors (power/feedback).

- Allow adequate cable length so the cables are not in tension.
- Molded mating electrical connectors on the cable dress package for pedestal RSW gun applications.
- Confirming full engagement of the cable dress connector to the appropriate mating receptacle on ServoWeld™ actuators.
- Earth ground the thrust rod when possible.

4.4 Mounting

Thrust Rod Attachment - Round Thrust Rod

The design of the Round Rod ServoWeld actuator allows the extending rod to rotate. This provides simple setup of the actuator by allowing the user to rotate the rod and thread it in and out of the actuator for mechanical attachment or system testing. This feature also requires that the rod be kept from rotating when used in its dedicated application to insure proper linear motion. In most applications, such as those where the load is coupled to an external mechanical guide, or some other support device, the load cannot rotate, and thus provides anti-rotation for the extending rod of the actuator.

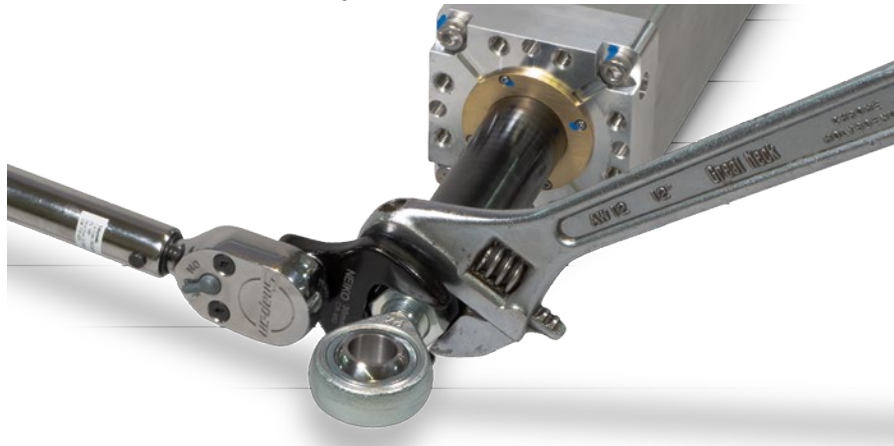

Figure 4.3: For round rod, hold thrust rod stationary using a wrench on the flats at the end of the rod when attaching accessories, linkages or load to the actuator. Use a torque wrench to tighten the interfacing rod end to the actuator threaded connection point. Torque values provided in Table 2.2

WARNING!

APPLYING TORQUE TO THE THRUST ROD MAY DAMAGE THE ACTUATOR. Avoid this by using a wrench to prevent the thrust rod from rotating while attaching the load, linkages or accessories to the rod end.

Thrust Rod Connection:

ROD END ATTACHMENT FOR ROUND ROD ACTUATOR: Hold flats on round rod stationary using a fixture, vise, or opposing wrench. Torque weld gun connection linkage or rod eye up to table value shown:

M12	80 N-m
	59 ft-lb

Table 4.1: Rod end torque recommendations

Trunnion Mount

Trunnion Mount – 25mm diameter male trunnion pins provided in bearing plate. Mate trunnions with integral trunnion receptacles on the weld gun. Ensure the actuator pivots on the trunnion pins without binding.

4.5 Water Cooling Option

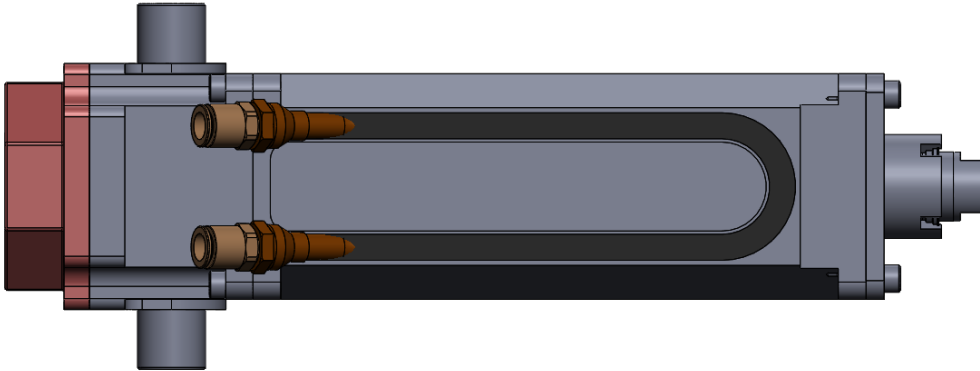

Figure 4.5: View of water cooling option

Water Flow Required:	1.9 to 3.8 LPM (0.5 to 1.0 GPM)
Water Inlet Temperature:	30° C (86° F) Max.
Coolant Line Connection:	10 mm tube fittings

5.0 CSWL ServoWeld™ Electrical Installation

5.1 EMC Wiring Guidelines

⚠ WARNING WARNING!

Thrust rod is not electrically connected to ground. The thrust rod should be earth grounded during installation for safety when possible.

Cable routing

It is recommended that the power and signal cables for ServoWeld™ actuators be routed as far apart as possible to minimize electrical noise in communication cables.

Over time, liquid contaminants such as oil and cleaning solutions may accumulate on the cables and into the connectors if they are an exposed type. To minimize the introduction of contaminants to the connector, route the cables so that there is a loop in the cable just prior to its attachment to the connector.

Examples are shown depending on the orientation of the connectors. Units mounted in such a way that the connectors are on the bottom surface of the actuator require no looping.

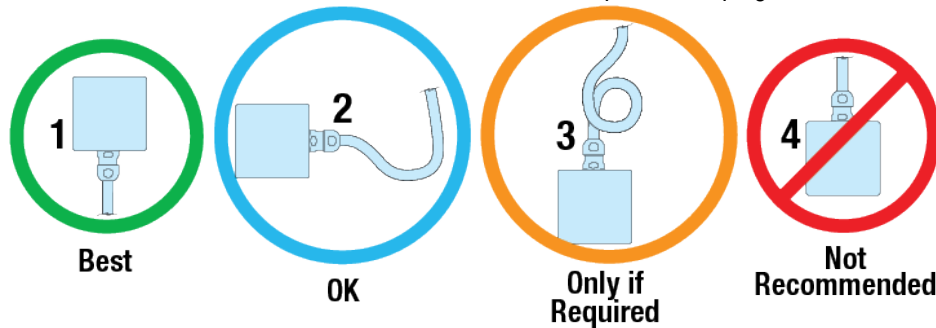

Figure 5.1: Recommended routing of ServoWeld cabling.

Shielding and grounding

Shielded cables are recommended. The standard cables provided by Tolomatic have an overall shield with drain wires and the case ground of the actuator is tied to a pin on the power connector. To minimize EMI and ensure system reliability, shield drain wires from all cables should be tied to a common earth ground.

⚠ WARNING WARNING!

Thrust rod is not considered an adequate ground.

5.2 Connector Orientation

The standard Tolomatic connectors are shown in figure 5.2 below. Tolomatic can mount the connectors in the orientation desired by the customer, or be rotated during installation. The ServoWeld™ actuator is manufactured to fit many different connector configurations. Many drive/robot manufacturers have specific connectors/pinout/wiring for integrating the ServoWeld actuator into operation. Reference Appendix B for available configurations. Depending on the connector choice, some connectors may be rotated from -90° to 180°.

For the Tolomatic standard connectors it is not necessary to loosen the screws retaining the connectors. Just carefully rotate to the desired orientation.

NOTE!

Do not apply excessive force while rotating connectors.

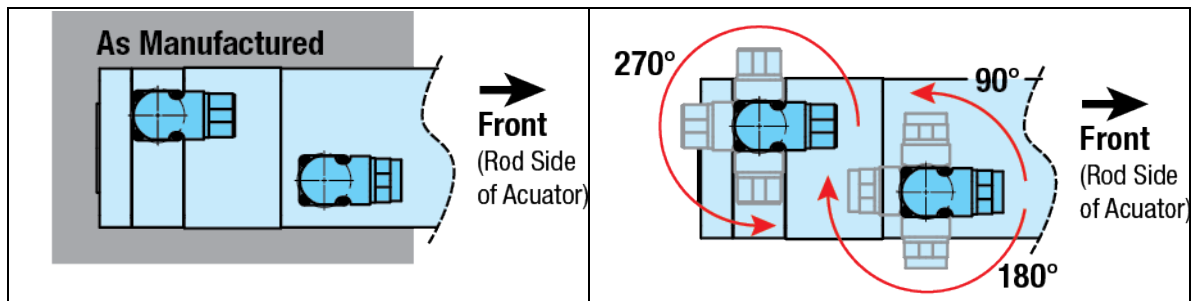

Figure 5.2: Connector rotation. Note that the Tolomatic standard connectors may be rotated from -90° to $+180^{\circ}$ allowing for cables to connect toward the front (rod end, as manufactured), to either side, both sides, or back of actuator.

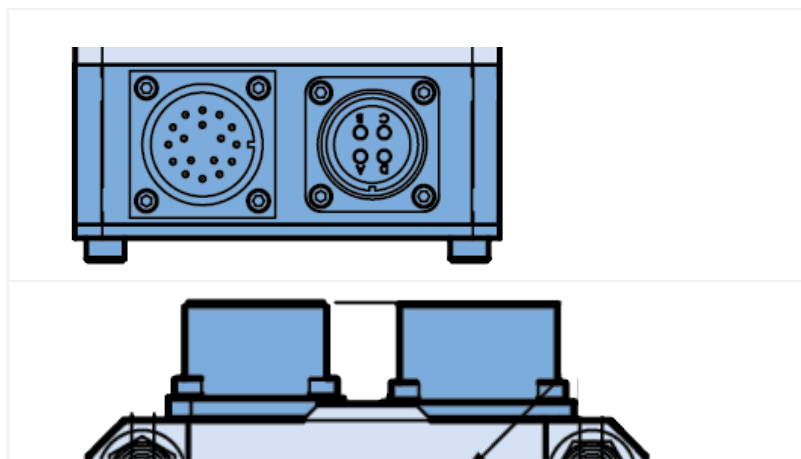

Figure 5.3: Drawing of box mount connectors used on some ServoWeld actuators.

See individual encoder/connector in section 5.5 for details.

5.3 Feedback Information

The selection of the feedback device is typically dictated by the RSW servo system drive or robot controller used to operate the actuator. Each RSW servo system drive or robot controller has specific requirements for the feedback on the motor. ServoWeld actuators may use an incremental, single-turn absolute, multi-turn absolute, or resolver type rotary feedback device. Not all resolver-based RSW servo system drives or robot controllers can use the same resolver, resolver alignment, or relative direction of resolver rotation. Many RSW servo system drives or robot controllers offer software that allows the entering of parameters or the downloading of "motor data files" that dictate how the feedback must be integrated with the motor. Tolomatic can provide the proper parameters to enter to create these "data files". Entering motor parameter data to some RSW servo system drives may require assistance from the RSW servo system drive/robot manufacturer.

5.3.1 Feedback Commutation

When Tolomatic manufactures a ServoWeld actuator, the proper feedback is selected, mounted, aligned and test run on an RSW servo system drive that is known to be equivalent to the RSW servo system drive that the

customer plans to use for confirming proper feedback alignment and operation.

Feedback Type	Offset Alignment	Electrical Degree Tolerance
Fanuc	330 Degrees	+/- 5 Degrees
ABB	90 Degrees	+/- 5 Degrees
KUKA	90 Degrees	+/- 5 Degrees

5.3.2 Feedback Commutation Details

Terminology in the industry varies from motor supplier to motor supplier. One example is in the labeling of phases; some suppliers will reference phase R, S and T while others refer to U, V and W. With the differences in terminology visual explanations are used for clarification purposes.

Tolomatic ServoWeld Actuator motors are wired such that as the torque generating current vector progresses from phase U -> V -> W positive rotation is created. Positive rotation is defined as clockwise as viewed from the front face of the actuator. For reference, positive rotation will cause the thrust rod to extend.

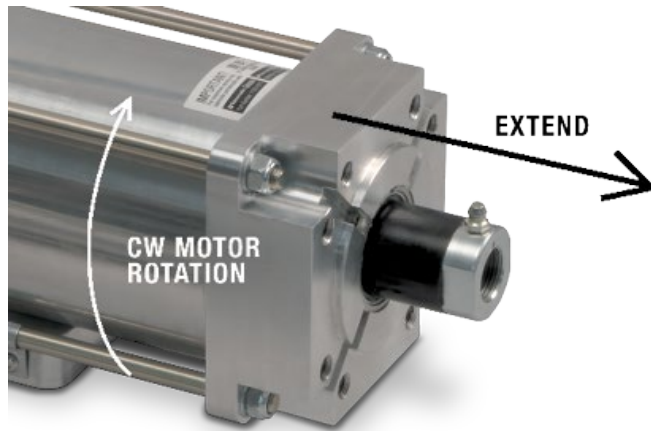

Figure 5.4: Thrust rod movement relative to motor rotation.

Absolute Encoder Feedback

The standard commutation offset for Hiperface, Hiperface DSL, and EnDat absolute encoders in Servoweld actuators is set to 0 electrical degrees. This is accomplished by first locking the motor rotor with a current vector from phase U (+) to phase V and W (-), and then sending a set-zero position command to the encoder using the appropriate programming tool. The proprietary absolute encoders from Fanuc and Nikon, are aligned to specific angles that work with certain robot controllers. The Fanuc and Nikon absolute encoders in Servoweld actuators are set to 330 and 30 electrical degrees. This is accomplished by first locking the motor rotor with a current vector from phase U (+) to phase V (-) for Fanuc and from phase U (+) to phase W (-) for Nikon. The feedback device location is adjusted mechanically for both feedback devices.

(See table 5.1)

Resolver Feedback

The ServoWeld Actuator family is also offered with resolver feedback. A resolver must be excited with a sinusoidal input and outputs two signals, commonly referred to as cos and sin. These signal's magnitude and the phase angle relative to the excitation voltage are used by the drive to determine the absolute position (single rotational) of the motor's armature.

These actuators are aligned with a current vector from phase V (+) to phase W (-). At this location, the resolver body is rotated until the cos signal is null, and the sin signal is in phase with the excitation frequency.

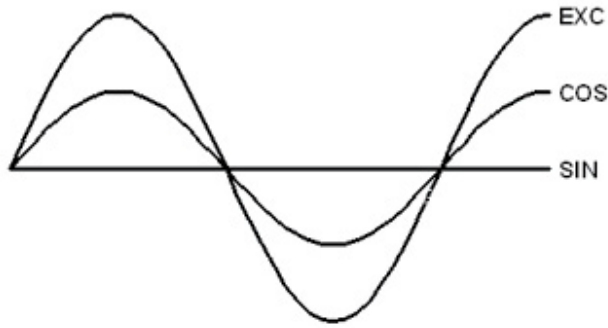

Figure 5.5: Motor rotational position at 0

Direction can be confirmed by rotating the shaft clockwise as viewed from the back, where, after 90 degrees of rotation the cos will now be in phase with the excitation frequency and the sin signal will be null.

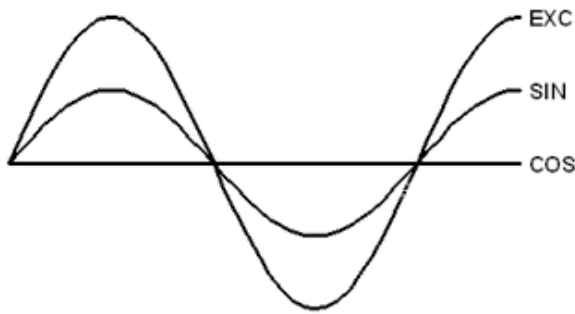

Figure 5.6: Motor rotational position at 90

Feedback Type	Offset Alignment	Electrical Degree Tolerance
Fanuc	330 Degrees	+/- 5 Degrees
Resolver TE	90 Degrees	+/- 5 Degrees
Resolver LTN	90 Degrees	+/- 5 Degrees
Hiperface	0 Degrees	+/- 5 Degrees
Hiperface DSL	0 Degrees	+/- 5 Degrees
EnDat 2.2	0 Degrees	+/- 5 Degrees
Nikon	30 Degrees	+/- 5 Degrees

Table 5.1: Absolute Encoder and Resolver feedback data

■ Servomotor Information:

NOTE!

See servomotor specifications in Appendix A.

NOTE!

Do NOT exceed 650Vdc or 365 Vdc depending on motor selected, as it may cause damage to the actuator. Supplying the motor more than 110% of the rated motor voltage may increase the rotational speed of the motor greater than its specified maximum speed, leading to premature failure of the actuator

⚠ CAUTION CAUTION!

In any case where it is determined that the feedback has become misaligned, or an RSW servo system drive change is made requiring the feedback to be aligned differently, it is recommended that Tolomatic be contacted and arrangements made to have that procedure performed.

5.4 Connector Pinouts

NOTE!

The correct robot motor file must be selected for each actuator, robot, and robot controller. Please contact Tolomatic on any questions related the correct motor file selection.

Feedback Code: A1 – ABB

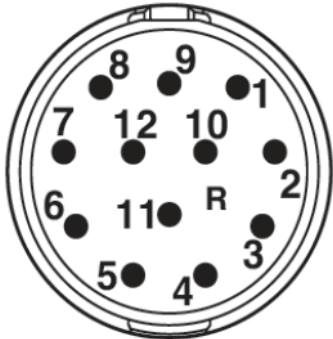
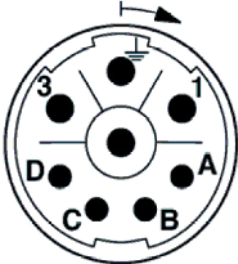
Feedback Type:	Resolver		
Feedback Supply Voltage:	Excitation 4 kHz		
Positive Phase Sequence causes the thrust tube to:	Extend		
FEEDBACK CONNECTOR:			
	Style:	Swivel	
	Manufacturer:	Phoenix Contacts	
	Manufacturer P/N:	RF-12P1N8AAD00	
	Insert Clocking:	Key over pin "9"	
	Feedback Connector Pinout:		
Pin	Signal	Pin	Signal
1	COS (S1)	7	NC
2	CPS LO (S3)	8	NC
3	SIN (S4)	9	NC
4	SIN LO (S2)	10	NC
5	EXC LO (R2)	11	NC
6	EXC (R1)	12	NC
MOTOR POWER CONNECTOR:			
	Style:	Swivel	
	Manufacturer:	Phoenix Contacts	
	Manufacturer P/N:	SF-7EP1N8AAD00	
	Clocking:	As Shown	
	Motor Power Connector Pinout:		
Pin	Signal	Pin	Signal
1	COS (S1)	A	Motor Thermal
2	CPS LO (S3)	B	Motor Thermal
3	SIN (S4)	C	NC
4	SIN LO (S2)	D	NC

⚠ WARNING WARNING!

Feedback device, wiring and connector design are intended to operate with chosen robot controller or servo drive. Please verify robot controller/servo drive and mating cable are integrated for use with ServoWeld™ actuator before attempting to operate. Damage to the actuator or unintended operation could occur if not properly matched.



Feedback Code: F1 - Fanuc/aiAR128

Feedback Type:	Absolute		
Feedback Supply Voltage:	+5V ±5%		
Positive Phase Sequence causes the thrust tube to:	Retract		
FEEDBACK CONNECTOR:			
	Style:	Box	
	Manufacturer:	Proprietary	
	Manufacturer P/N:	Proprietary	
	Insert Clocking:	As shown	
	Feedback Connector Pinout:		
Pin	Signal	Pin	Signal
1	NC	6	RD
2	NC	7	0 V
3	NC	8	+5 V
4	+6 V A	9	+5 V
5	RD -	10	0 V
MOTOR POWER CONNECTOR:			
	Style:	Box	
	Manufacturer:	Amphenol	
	Manufacturer P/N:	MS3102A18-10P	
	Clocking:	Key between pins "A" & "D"	
	Pin	Signal	
A	Phase R (U)		
B	Phase S (V)		
C	Phase T (W)		
D	GND		

⚠ WARNING WARNING!

Feedback device, wiring and connector design are intended to operate with chosen robot controller or servo drive. Please verify robot controller/servo drive and mating cable are integrated for use with ServoWeld™ actuator before attempting to operate. Damage to the actuator or unintended operation could occur if not properly matched.

Feedback Code: K1 - KUKA

Feedback Type:	Resolver				
Feedback Supply Voltage:	Excitation 4 kHz				
Positive Phase Sequence causes the thrust tube to:	Retract				
FEEDBACK CONNECTOR:					
	Style:	Swivel			
	Manufacturer:	Intercontec			
	Manufacturer P/N:	AEDC 052 MR04 00 0200 000			
	Insert Clocking:	Key over pin "8"			
	Feedback Connector Pinout:				
Pin	Signal		Pin	Signal	
1	SIN (S2)		7	EXC LO (R2)	
2	SIN LO (S4)		8	Motor Thermal	
3	NC		9	Motor Thermal	
4	NC		10	EXC (R1)	
5	NC		11	COS (S1)	
6	GND		12	COS LO (S3)	
MOTOR POWER CONNECTOR:					
	Style:	Swivel			
	Manufacturer:	Intercontec			
	Manufacturer P/N:	BEDC 106 MR14 00 0200 000			
	Clocking:	As Shown			
	Motor Power Connector Pinout:				
Pin	Signal		Pin	Signal	
1	Phase R (U)		4	BRK + (IF AVAIL.)	
2	Phase S (V)		5	BRK - (IF AVAIL.)	
3	GND		6	Phase T (W)	

⚠ WARNING WARNING!

Feedback device, wiring and connector design are intended to operate with chosen robot controller or servo drive. Please verify robot controller/servo drive and mating cable are integrated for use with ServoWeld™ actuator before attempting to operate. Damage to the actuator or unintended operation could occur if not properly matched.

Feedback Code: M1 - MOTOMAN YASKAWA

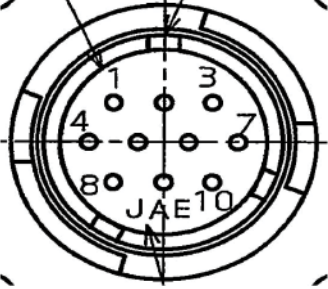
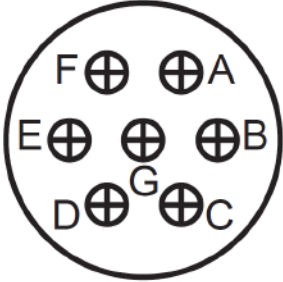
Feedback Type:	Absolute		
Feedback Supply Voltage:	DC +5V ±5%		
Positive Phase Sequence causes the thrust tube to:	Retract		
FEEDBACK CONNECTOR:			
	Style:	BOX	
	Manufacturer:	JAE	
	Manufacturer P/N:	JN2AS10ML1	
	Insert Clocking:	As shown	
	Feedback Connector Pinout:		
Pin	Signal	Pin	Signal
1	DATA +	6	BATTERY +
2	DATA	7	FRAME GROUND
3	NC	8	NC
4	+5 VDC	9	0 V
5	BATTERY -	10	NC
MOTOR POWER CONNECTOR:			
	Style:	Box	
	Manufacturer:	Amphenol	
	Manufacturer P/N:	MS3102A20-15P	
	Clocking:	Key between pins "A" & "F"	
	Motor Power Connector Pinout:		
Pin	Signal	Pin	Signal
A	Phase T (W)	E	Motor Thermal
B	Phase S (V)	F	Motor Thermal
C	Phase R (U)	G	NC
D	GND		

⚠ WARNING WARNING!

Feedback device, wiring and connector design are intended to operate with chosen robot controller or servo drive. Please verify robot controller/servo drive and mating cable are integrated for use with ServoWeld™ actuator before attempting to operate. Damage to the actuator or unintended operation could occur if not properly matched.

Feedback Code: N1 - NACHI; FD11

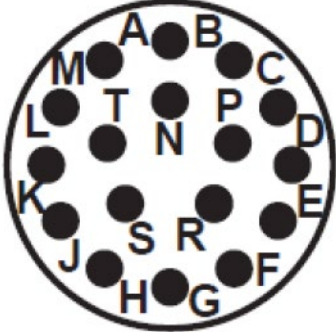
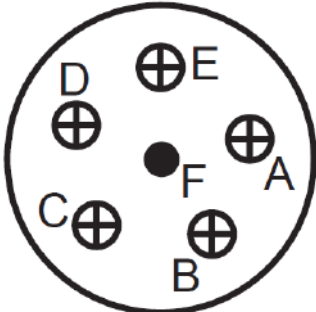
Feedback Type:	Absolute			
Feedback Supply Voltage:	DC +5V ±5%			
Positive Phase Sequence causes the thrust tube to:	Retract			
FEEDBACK CONNECTOR:				
	Style:	BOX		
	Manufacturer:	Amphenol		
	Manufacturer P/N:	MS3102A20-29P		
	Insert Clocking:	Key over pin "A"		
	Feedback Connector Pinout:			
	Pin	Signal	Pin	Signal
	A	NC	K	NC
	B	NC	L	NC
	C	NC	M	Motor Thermal
	D	NC	N	Motor Thermal
E	SD+	P	NC	
F	SD-	R	NC	
G	GND	S	BAT -	
H	Vcc	T	BAT +	
J	GND			
MOTOR POWER CONNECTOR:				
	Style:	Box		
	Manufacturer:	Amphenol		
	Manufacturer P/N:	MS3102A20-17P		
	Clocking:	Key over pin "E"		
	Pin	Signal	Pin	Signal
A	Phase T (W)	D	NC	
B	Phase S (V)	E	NC	
C	Phase R (U)	F	GND	

⚠ WARNING WARNING!

Feedback device, wiring and connector design are intended to operate with chosen robot controller or servo drive. Please verify robot controller/servo drive and mating cable are integrated for use with ServoWeld™ actuator before attempting to operate. Damage to the actuator or unintended operation could occur if not properly matched.

Feedback Code: P1 – Parker LTN

Feedback Type:	Resolver		
Feedback Supply Voltage:	Excitation 4kHz		
Positive Phase Sequence causes the thrust tube to:	Extend		
FEEDBACK CONNECTOR:			
	Style:	Swivel	
	Manufacturer:	Phoenix Contacts	
	Manufacturer P/N:	MS3102A20-29P-W	
	Insert Clocking:	Key over pin "9"	
	Feedback Connector Pinout:		
Pin	Signal	Pin	Signal
1	COS (S1)	7	Motor Thermal
2	COS LO (S3)	8	Motor Thermal
3	SIN (S4)	9	NC
4	SIN LO (S2)	10	NC
5	EXC LO (R2)	11	NC
6	EXC (R1)	12	NC
MOTOR POWER CONNECTOR:			
	Style:	Swivel	
	Manufacturer:	Phoenix Contacts	
	Manufacturer P/N:	SF-7EP1N8AAD00	
	Clocking:	As Shown	
	Motor Power Connector Pinout:		
Pin	Signal	Pin	Signal
1	Phase R (U)	A	NC
PE	PE	B	NC
3	Phase S (V)	C	NC
4	Phase T (W)	D	NC

⚠ WARNING WARNING!

Feedback device, wiring and connector design are intended to operate with chosen robot controller or servo drive. Please verify robot controller/servo drive and mating cable are integrated for use with ServoWeld™ actuator before attempting to operate. Damage to the actuator or unintended operation could occur if not properly matched.

6.0 CSWL Operation and Start Up Considerations

6.1 Attaching Cables & Homing / Mechanical Travel Limits

1. Carefully align each cable connector with the respective motor connector.
2. Fully seat the cable to the feedback and power connectors.
3. Verify continuity and functionality of the thermal switch signals, TS+ and TS-. These signals are transmitted through the cables that connects the motor to its motion control system.
4. When homing the ServoWeld™ actuator avoid excessive force. During homing do not exceed 20% of continuous thrust or speeds of 0.1 in/sec (2.5 mm/sec).exceeding these recommendations can cause permanent damage to the actuator. Careful attention should always be taken to prevent exceeding the physical limits of the actuator.

CAUTION! CAUTION!

The mechanical travel limits of the actuator must be verified to ensure the actuator will not reach an internal hard limit during normal operation. The end of stroke bumpers should NOT be engaged during normal programmed servo actuator operation.

6.2 Brake

WARNING! WARNING!

In all vertical application an un-powered ServoWeld CSWL actuator will require a brake to maintain position. Tolomatic recommends that the nominal back drive force specification (listed on page 26) be used for reference only. Back drive force is subject to change throughout the life of the actuator, due to mechanical break in, ambient temperature, and duty cycle variation.

A brake can be used with the actuator to keep it from backdriving, typically in vertical applications. A brake may be used for safety reasons or for energy savings allowing the actuator to hold position when un-powered.

NOTE!

The optional Spring-Applied / Electronically-Released Brake typically requires 24V or 90V power (depending on robot manufacturer).

The brake is spring engaged and electrically released.

CAUTION! CAUTION!

DO NOT attempt to operate the actuator with the brake applied. Allowing the actuator to operate with the brake applied may cause serious damage to the actuator and/or the brake. Do not use the brake to support heavy loads while an operator is under the load. Provide another means to lock the load in position. The brake is a spring applied friction mechanism and does not provide a positive lock.

ServoWeld™ Brake Specifications

	SERIES	CSW_
ROTOR INERTIA	gm-cm ²	73
	oz-in ²	0.399
CURRENT	Amp	0.45
HOLDING TORQUE	N-m	4.0
	In-lb	35
ENGAGE TIME	mSec	50

	SERIES	CSW_
ENGAGE TIME WITH DIODE	mSec	100
DISENGAGE TIME	mSec	50
VOLTAGE	Vdc	24

Table 6.1: ServoWeld brake specifications

Protecting the brake from voltage transients in applications where it will be engaged and disengaged frequently is advised. The use of a rectifying diode and zener diode will provide optimal protection against these transients.

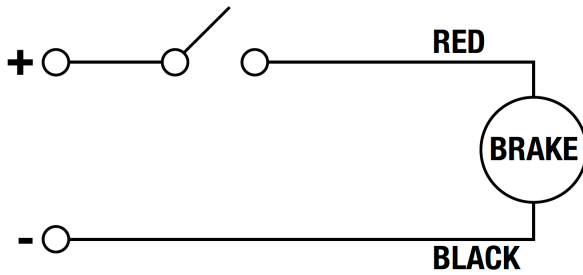

Figure 6.2: Fastest Engage / Disengage time, least protection

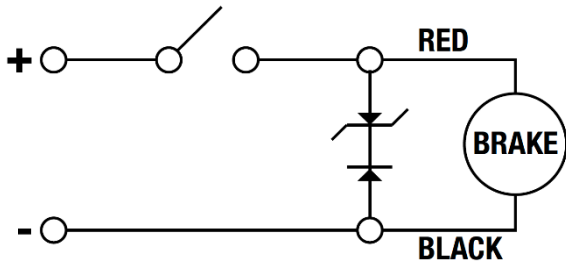

Figure 6.3: Increased Engage / Disengage time, best protection

7.0 Maintenance & Repair

7.1 Lubrication

NEW UNIT: All ServoWeld™ actuators have been lubricated at the factory and are ready for installation. If the actuator is placed in storage for more than 1 year after it is received, the actuator should be lubricated through the lubrication port on the thrust rod with 20 grams (0.7 oz) or 23 ml (0.75 fl oz) of Kluber Isoflex Topas NCA52 grease (Tolomatic, PN: 1150-1017) and cycled at least two full strokes prior to running in a loaded condition.

Lubrication needs in a given application are dependent on multiple factors:

- Ambient temperature of environment
- Weld Schedule:
 - Number of open/close (long moves) per minute
 - Number of welds per minute
 - Actuator thrust rod force required

7.2 Periodic Maintenance

PERIODIC MAINTENANCE: The forces in different applications impact the life of the grease in the actuator. Tolomatic recommends a simple, 5 minute maintenance procedure based on Table 7.1 for typical weld gun styles. For questions about your specific application, contact Tolomatic Customer Support.

Weld Gun Type	PM Schedule (weld cycles)
C gun	10,000,000
X gun / Pinch gun	5,000,000

Table 7.1: Periodic Maintenance schedule.

For optimal performance and maximum life, consider performing this simple maintenance every 5,000,000 weld cycles.

NOTE!

Tolomatic also recommends validating the output force after 100 000 cycles and on an annual basis thereafter. It is recommended that the actuator be visually inspected after initial startup and twice a year thereafter, specifically checking for uneven wear or discoloration of the thrust rod which may indicate side loading and lead to premature seal failure. Contact the nearest Tolomatic service center with any concerns or questions.

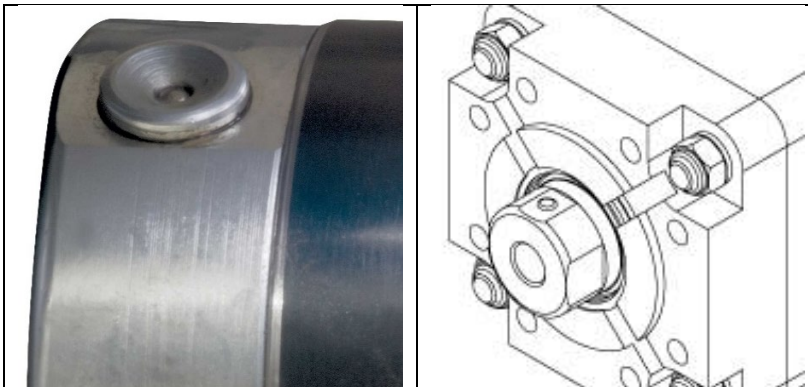

Figure 7.1: A flush grease zerk allows periodic relubrication for ServoWeld actuators. This can typically be performed in 5 minutes without removing the actuator from its installation.

■ Procedure for lubrication

NOTE!

Before starting any maintenance activities, confirm ServoWeld actuator is in full retract position and supply power is shut off.

1. Ensure ServoWeld actuator is in full retract position
2. Using a standard grease gun, apply the following amounts of grease into the grease Zerk on the rod end of the actuator:
 - a. CSWL 3: 20 grams (0.7 oz) or 23 ml (0.75 fl oz)

NOTE!

Use Kluber Isoflex Topas NCA52 grease. Available from Tolomatic, PN: 1150-1017

3. Re-apply power to the ServoWeld actuator
4. Using the Robot teach pendant, complete five full extend / full retract moves of the ServoWeld actuator at low speed / low force to properly distribute the grease

CAUTION! CAUTION!

Do not over-fill with grease

Overfilling will cause a reduction in performance, excessive heat build up and potential premature failure.

■ 7.3 ServoWeld™ Refurbishment & Remanufacturing Service

Tolomatic factory refurbishment or remanufacturing service is available for any ServoWeld™ actuator. This service will return the ServoWeld actuator to factory specs.

Refurbishment Service includes:

- Replace thrust rod
- Replace wiper/scrapper components
- Visually inspect for additional worn or broken components
- Clean roller screw and nut
- Re-lubricate the roller screw and nut
- Re-assemble the actuator
- Functional test to assure unit is fully operational to original specifications

Remanufacturing Service includes:

- Replace thrust rod
- Replace wiper/scrapper components
- Visually inspect for additional worn or broken components
- Replace roller screw/nut assembly
- Replace main bearing
- Re-assemble the actuator
- Functional test to assure unit is fully operational to original specifications
- 1 year warranty from date of shipment

Appendix A: Actuator Specifications

Table 1: Performance & Mechanical Specifications:

SERIES		CSWL	
FRAME SIZE	mm	82.6 x 86.3 (Fanuc encoder is 90 x 90)	
	in	3.25 x 3.40 (Fanuc encoder 3.54 x 3.54)	
MOTOR WINDING		A3 / B3	
NUT/SCREW		RN05	RN10
SCREW LEAD	mm	5.0	10.0
PEAK FORCE	kN	13.0	7.0
	lbf	2923	1574
MAX. VELOCITY	mm/sec	291.7	583.3
	in/sec	11.5	23.0
SCREW DLR (DYNAMIC LOAD RATING)	kN	53.6	47.2
	lbf	12,050	10,600
NOMINAL BACK DRIVE FORCE	N	347	173
	lbf	78	39
WEIGHT*	kg	4.774	4.794
	lbf	10.42	10.47
STROKE	mm	152	152
	in	6.0	6.0
BASE INERTIA	kg-cm ²	4.147	4.152
	lb-in	1.4170	1.4189
MAX. SIDE LOAD (150 mm)	N	75	
	lbf	17	
AMBIENT TEMP ** RANGE	°C	0 to 50	
	°F	32 to 122	
IP RATING	Standard IP65 (static)		
AGENCY LISTINGS	CE		

*Weight varies per feedback device or mounting option. See table below for details.

**From 0-10°C (32-50°F), additional startup procedure may be required for optimal performance. See user manual for details.

***Weight adder for K1 option includes weight of brake

****In all vertical application an un-powered Tolomatic ServoWeld Actuator will require a brake to maintain position. Tolomatic recommends that the nominal back drive force specification be used for reference only. Back drive force is subject to change throughout the life of the actuator, due to mechanical break in, ambient temperature, and duty cycle variation.

Table 2: CSWL Weight adder

		Weight Adder				
		Add For Feedback Device				
	Water Cooling	F1	M1	A1	K1***	W1
kg	0.176	1.203	1.851	1.427	2.283	2.013
lb	0.389	2.653	4.081	3.145	5.032	4.438

SNOTE: Screw/Lead Accuracy: 0.023 mm/300 mm; .0009in/ft

Motor Specifications:

Table 3: Motor Specifications:

MOTOR WINDING		SERIES	CSWL	
			MV23	MV43
TORQUE CONSTANT (K_t)		N-m/A Peak	0.66	1.27
		<i>in-lb/A Peak</i>	<i>5.84</i>	<i>11.27</i>
VOLTAGE CONSTANT (K_e)		V/Krpm Peak	79.8	154.0
STALL TORQUE	Radiant Cooled	N-m	4.3	4.3
		<i>in-lb</i>	<i>38.0</i>	<i>38.0</i>
	Water Cooled	N-m	8.6	8.6
		<i>in-lb</i>	<i>76.0</i>	<i>76.0</i>
CONTINUOUS STALL CURRENT	Radiant Cooled	A_{RMS}	5.0	2.5
	Water Cooled	A_{RMS}	10.0	5.0
PEAK TORQUE		N-m	14.58	14.58
		<i>in-lb</i>	<i>129.0</i>	<i>129.0</i>
PEAK CURRENT		A_{RMS}	17.0	8.5
RESISTANCE		Ohms	2.07	8.28
INDUCTANCE		mH	3.8	15.0
BUS VOLTAGE		V_{RMS}	230	460
SPEED @ RATED V		RPM	3500	3500
NO. OF POLES			8	8

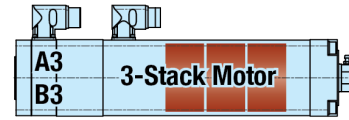

MOTOR WINDING
A3
B3 = 3 Stack Motor

Standard Thermal Switch Specifications

The motor windings have an integral normally closed thermal switch or resistance based temperature measurement device. These devices must be integrated with the robot controller. The switch opens at a temperature of 266° F (130°C), which is the windings maximum operating temperature. The thermal switch is meant to protect the windings, the actuators continuous operating region must still be obeyed. Operation that causes the windings temperature to approach 266° F (130° C) will reduce the expected life of the actuator.

Appendix B: Troubleshooting Procedure

SYMPTOM	POTENTIAL CAUSE	SOLUTION
No response from actuator	Controller / Drive not enabled	Enable Controller/Drive
	Controller / Drive faulted	Reset the Controller/Drive
	Improper / Failed wiring	Check the wiring
Drive is enabled but actuator is not operating or is operating erratically	Improper robot motor file selected	Confirm motor file selection with robot manufacturer
	Improper ServoWeld / gun system calibration in robot controller	Confirm ServoWeld / gun system has been calibrated per robot manufacturer calibration procedure
	Feedback wiring may be incorrect	Verify feedback wiring
Actuator is operating but is not up to rated speeds/force	Improper robot motor file selected	Confirm motor file selection with robot manufacturer
	Improper ServoWeld / gun system calibration in robot controller	Confirm ServoWeld / gun system has been calibrated per robot manufacturer calibration procedure
	Motor phases are wired incorrectly or in incorrect order	Verify correct wiring of motor armature
	Drive may be improperly tuned	Check all gain settings
	Drive may be set up improperly for ServoWeld actuator used	Check drive settings for number of poles, voltage, current, resistance, inductance, inertia, etc.
	Feedback is improperly aligned	Contact Tolomatic
Actuator cannot move	Force is too large for the capacity of the actuator or too much friction is present	Verify force requirements
	Excessive side load	Verify correct operation
	Misalignment of output rod to application	Verify correct alignment
	Drive has too low of current capacity or is limited to tool low of current capacity	Verify correct drive and settings
	Actuator has crashed into hard stop	Disconnect from load and manually move away from hard stop. If problem persists, contact Tolomatic for service.
Actuator housing moves or vibrates when shaft is in motion	Loose mounting	Check actuator mounting
	Drive is improperly tuned – wrong gain settings	Tune drive
Actuator is overheating	Improper robot motor file selected	Confirm motor file selection with robot manufacturer
	Improper ServoWeld / gun system calibration in robot controller	Confirm ServoWeld / gun system has been calibrated per robot manufacturer calibration procedure
	Duty cycle is higher than actuator ratings	Verify duty cycle is within continuous ratings
	Drive is poorly tuned, causing excessive unnecessary current to be applied to motor	Check gain settings

SYMPTOM	POTENTIAL CAUSE	SOLUTION
	Actuator low or out of grease	Re-lubricate (if applicable)
Overheat fault - however actuator is not hot	Cable broken or connector disconnected	Replace faulty cable and/or insure proper connections

■ APPENDIX C: Warranty

■ C.1 Warranty

■ Warranty and Limitation of Liability

Tolomatic's complete terms and conditions can be found here <https://www.tolomatic.com/info-center/resource-details/terms-and-conditions>

■ Limited Warranty

Tolomatic warrants that at the time of delivery, Products shall be in good condition, free from defects in material and workmanship and that Products made to order shall conform to applicable drawings or specifications as referenced in the quotation or accepted purchase order ("Product Warranty"). The Product Warranty shall expire one year from date of shipment (the "Warranty Period"). Tolomatic warrants that Buyer shall acquire good title to the Products free from third party rights. These warranties are given only to Buyer and not to any third party.

The Product Warranty excludes any defects or non-conformance resulting (wholly or in part) from: (i) accidental damage, mishandling, incorrect installation, negligence or other circumstances arising after delivery; (ii) the repair or alteration of the Product by any party other than Tolomatic or its authorized representative; (iii) the failure by Buyer to provide a suitable storage, use, or operating environment for the Products; (iv) Buyer's use of the Products for a purpose or in a manner other than that for which they were designed; and (v) other abuse, misuse or neglect of the Products by Buyer or any third party.

The Product Warranty excludes any Products not manufactured by Tolomatic. Insofar as any Products are manufactured by third parties, Tolomatic shall, insofar as it can, pass to the Buyer the benefit of all warranties given by the supplier of such Products.

The Product Warranty shall be limited to defects of which Tolomatic is notified within twenty-one (21) days from the date of shipment to Buyer or, in the event of latent defects, within twenty-one (21) days of the defect being discovered and provided that such notice is received within the Warranty Period. As sole remedy for the breach of the warranty in paragraph (a) above, provided that (if required by Tolomatic) all non-conforming Products are returned to Tolomatic at Buyer's cost, and provided that Tolomatic confirms the defect or non-conformance, Tolomatic shall at its option (i) replace or repair the defective or non-conforming items, or correct any defective work or non-conformance, or (ii) refund to Buyer the original purchase price of the defective or non-conforming item and reimburse to Buyer any transportation and insurance charges incurred by Buyer.

Any claim by Buyer against Tolomatic alleging the breach of the Product Warranty must be commenced within twelve (12) months following the date of the alleged breach.

In the event the parties disagree whether or not a breach of the Product Warranty has occurred, Tolomatic may (but shall not be obliged to) undertake any repairs or replacement requested by Buyer pending final settlement of the matter. If it is determined that no such breach has occurred, Buyer shall pay Tolomatic upon demand the reasonable price of the repairs, corrections, or replacements made by Tolomatic including allowances for overheads and a reasonable profit margin.

THE WARRANTIES EXPRESSLY MADE UNDER THESE TERMS ARE EXCLUSIVE AND GIVEN IN LIEU OF ALL OTHER REPRESENTATIONS, WARRANTIES AND COVENANTS THAT MAY BE IMPLIED BY LAW, BY CUSTOM OF TRADE, BY THESE TERMS, BY THE PURCHASE ORDER OR OTHERWISE WITH RESPECT TO THE PRODUCTS. TO THE FULL EXTENT PERMITTED BY LAW, TOLOMATIC DISCLAIMS AND BUYER WAIVES ALL SUCH REPRESENTATIONS, WARRANTIES AND COVENANTS INCLUDING BUT NOT LIMITED TO, ANY IMPLIED WARRANTIES OF MERCHANTABILITY, FITNESS FOR A PARTICULAR PURPOSE OR NON-INFRINGEMENT OF THIRD PARTY INTELLECTUAL PROPERTY RIGHTS. BUYER'S SOLE REMEDY FOR BREACH OF WARRANTY IS STATED IN PARAGRAPH (d) ABOVE.

No Products shall be returned without Tolomatic's prior written consent. Products which Tolomatic consents to have returned shall be shipped by Buyer at Buyer's risk and expense, freight prepaid, to such location as Tolomatic designates.

■ Limitation of Liability

Tolomatic shall in no event be liable to Buyer or any third party, whether in contract, tort (including negligence), misrepresentation, strict liability or otherwise, for any incidental, punitive, consequential, indirect or special damages, including any loss of profits or savings or anticipated profits or savings, loss of data, loss of opportunity, loss of reputation, loss of goodwill or business or potential business, however caused, even if Tolomatic has been advised of the possibility of such damages in advance.

Under no circumstances shall Tolomatic's liability to Buyer in connection with any purchase order or Products supplied to Buyer exceed an amount equal to the amount paid by Buyer for such Products.

Buyer agrees and understands that it is solely Buyer's responsibility to ensure that Products are suitable for Buyer's requirements and for the environment, facilities or machinery for which they are intended by Buyer or by its end-customer to be fitted or used. Even if Tolomatic is advised of Buyer's intended use, Tolomatic makes no representation or warranty that the Product will be suitable for that purpose. Any technical advice furnished by Tolomatic relating to the intended use of the Products is given for information only and Tolomatic assumes no obligation or liability for the advice given or the results obtained. Except insofar as specifications or drawings form part of a purchase order and the Product Warranty, to the full extent permitted by law, Tolomatic disclaims and Buyer waives all representations, warranties and covenants that may be implied from the provision by Tolomatic of technical advice or information about Product. All such advice and information are accepted by Buyer at its risk.

Insofar as any liability or warranty of Tolomatic cannot be limited or excluded under applicable law, including any laws that do not permit limitations on liability relating to death or personal injury, the provisions of these terms and conditions shall be construed as being subject to such legal limitations, but only if those legal provisions have effect in relation to Tolomatic's liability notwithstanding the governing law provision in Section 18

■ Product Return Procedure

1. Before initiating the RMA process and obtaining an RMA number, please contact the Tolomatic Technical Support team to determine if it is possible to correct the issue in the field.
2. If an RMA is needed your Tolomatic Technical support team will initiate the RMA process and set up an RMA number.

USA - Headquarters Tolomatic Inc. 3000 County Road 116 Hamel, MN 55340, USA Phone: (763) 478 8000 Toll-Free: 1-800-328-2174 sales@tolomatic.com www.tolomatic.com	MEXICO Centro de Servicio Parque Tecnológico Innovación Int. 23, Lateral Estatal 431, Santiago de Querétaro, El Marqués, México, C.P. 76246 Phone: +1 (763) 478-8000 help@tolomatic.com	EUROPE Tolomatic Europe GmbH Friedrichstr. 20 65428 Hueselheim Germany Phone: +49 6142 17604 0 help@tolomatic.eu	CHINA Tolomatic Automation Products (Suzhou) Co. Ltd. No. 60 Chusongye Street, Building 2 Huoji District, SND Suzhou Jiangsu 215011 P.R. China Phone: +86 (512) 6750-0506 TolomaticChina@tolomatic.com
---	---	---	---

■ Appendix D: Declaration of Conformity

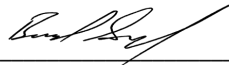
CE	Tolomatic TM EXCELLENCE IN MOTION	CE
EU Declaration of Conformity		
No: 36004716_01		
We the manufacturer,		
Tolomatic 3800 County Road 116 Hamel, MN 55340 USA		
declare under our sole responsibility that the product(s),		
CSWL Actuators		
All Models		
Fulfills the essential requirements of the following directives:		
LVD Directive (2014/35/EU) EN60034-1:2010/AC:2010 Rotating electrical machines Part 1 Rating and performance		
RoHS Directive (2011/65/EU, as amended by (EU) 2015/863)		
REACH (Regulation (EC) No 1907/2006)		
Assumption of conformity is based on the application of the harmonized or applicable technical standards and, when applicable or required, a European community notified body certification.		
 _____ Brad Schulz Director of Engineering & Technology		_____ 28.10.2022 Date of Issue (dd.mm.yyyy)

© 2022 Tolomatic

Tolomatic. All rights reserved.

Tolomatic and Excellence In Motion are registered trademarks of Tolomatic Incorporated. All other products or brand names are trademarks of their respective holders. www.tolomatic.com

2750-4043_02 CSWL Manual



Tolomatic™
EXCELLENCE IN MOTION

COMPANY WITH
QUALITY SYSTEM
CERTIFIED BY DNV GL
= ISO 9001 =
Certified site: Hamel, MN

USA - Headquarters	MEXICO	EUROPE	CHINA
Tolomatic Inc. 3000 County Road 116 Hamel, MN 55340, USA Phone: (763) 478-8000 Toll-Free: 1-800-328-2174 sales@tolomatic.com www.tolomatic.com	Centro de Servicio Parque Tecnológico Innovación Int. 23, Lateral Estatal 431, Santiago de Querétaro, LI Marqués, México, C.P. 76246 Phone: +1 (763) 478-8000 help@tolomatic.com	Tolomatic Europe GmbH Elisabethenstr. 20 65128 Rüsselsheim Germany Phone: +49 6142 17604 0 help@tolomatic.eu	Tolomatic Automation Products (Suzhou) Co. Ltd. No. 80 Chongye Street, Building 2 Huqin District, SND Suzhou Jiangsu 215011 P.R. China Phone: +86 (512) 6750-8506 TolomaticChina@tolomatic.com

All brand and product names are trademarks or registered trademarks of their respective owners. Information in this document is believed accurate at time of printing. However, Tolomatic assumes no responsibility for its use or for any errors that may appear in this document. Tolomatic reserves the right to change the design or operation of the equipment described herein and any associated motion products without notice. Information in this document is subject to change without notice.

Visit www.tolomatic.com for the most up-to-date technical information